

# STIGA



## **WORKSHOP MANUAL**

### **VILLA 2000-2021**



Edition	Manual	Chapter	Page
2008-05-19	Workshop Manual, Stiga Villa/Ready	1 General	1

## 1 General instructions

### Contents in this chapter

<b>1.1 Introduction</b> .....	<b>2</b>	1.3.2 Exeptions .....	4
1.1.1 Responsibility declaration .....	2	1.3.3 Conditions for validity of	
1.1.2 How this manual is used .....	2	the warranties .....	4
1.1.3 Abbreviations .....	2	<b>1.4 Unpacking and assembly</b> .....	<b>5</b>
<b>1.2 Safety Precautions</b> .....	<b>2</b>	1.4.1 Unpacking .....	5
1.2.1 Symbols and general		1.4.2 Battery .....	6
warnings .....	3	1.4.3 Assembly .....	7
1.2.2 Warm parts .....	3	1.4.4 Final checks .....	9
1.2.3 Moving parts .....	3	<b>1.5 Service</b> .....	<b>10</b>
1.2.4 Lifting and blocking up .....	3	1.5.1 First Service .....	11
1.2.5 Cleanliness .....	3	1.5.2 Intermediadate Service .....	11
1.2.6 Tightening torque .....	3	1.5.3 Basic Service .....	12
1.2.7 Sharp edges .....	3	1.5.4 Description of service points.	13
1.2.8 Replacement parts .....	3	<b>1.6 Technical specifications</b> .....	<b>16</b>
1.2.9 Inspection .....	3	1.6.1 General tightening torque .....	16
<b>1.3 Guarantee</b> .....	<b>4</b>		
1.3.1 Component guarantee,			
chassis .....	4		

### General

This Manual do not cover repair instructions for the motors. Regarding motors, contact the respective representative in the actual country.

This Manual and its specifications are valid for machines in their original design. In case of modified or changed machine, i.e. the motor is replaced, the manual accordance is limited.

The manual is divided in the following chapters:

**Chapter 1 is this chapter**

**Chapter 2 Chassis**

**Chapter 3 Steering**

**Chapter 4 Hydraulic system**

**Chapter 5 Belts**

**Chapter 6 Control Wires**

**Chapter 7 Electrical system**

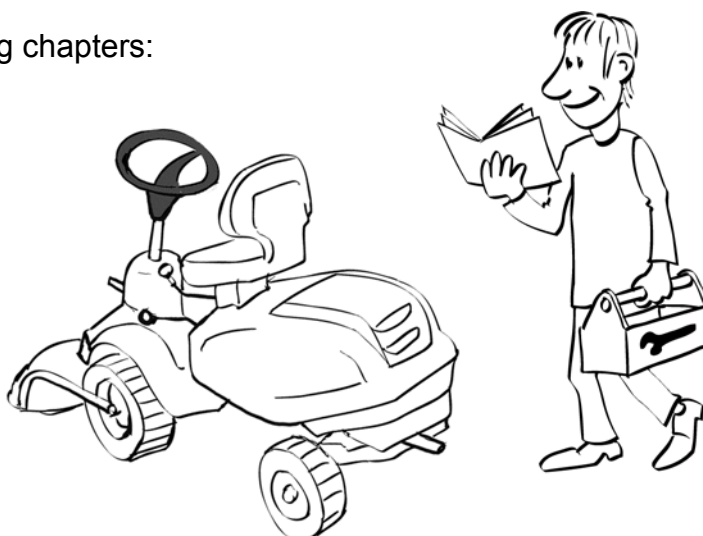



Edition	Manual	Chapter	Page
2008-05-19	Workshop Manual, Stiga Villa/Ready	1 General	2

## 1.1 Introduction

### 1.1.1 Responsibility declaration

In spite of the great care we have taken there may be errors in this publication. The author cannot be made liable for incorrect or missing information. GGP SE reserves the right to regularly change product specifications without prior notice. All the information in this book is based on the information available at the time of production. Illustrations and photographs may be arranged schematically, which implies that one picture may cover several models and therefore not correspond exactly with all models.

### 1.1.2 How this manual is used

To make this manual easy to understand we have divided the machine into its main systems and components. These parts are now the different chapters in the book.

Each chapter is divided up into sections.

There is a quick-guide on the cover of this book, which refers to the different chapters. In each chapter there is a detailed table of contents so that you can easily and quickly find what you are looking for.

For example, if you are looking for information on the Accessory Lifter you will find this in chapter 3, Chassis and Body. On the first page in chapter 3 there is a detailed table of contents which refers to the correct section, in this case section 3.1.

Always check that you are reading the right chapter for your particular machine before starting the repair work.

### 1.1.3 Abbreviations

The following abbreviations are used in this manual:

HST Hydrostatic Transmission

PTO Power Take Off

## 1.2 Safety Precautions

This manual has been written primarily for trained mechanics working in a well-equipped workshop. Nevertheless, the manual contains such detailed information that it can also be of use to owners who wish to carry out simple service and repairs on their machine.

A basic knowledge of repairs, tools and repair instructions is, however, always a prerequisite for first-rate results.

A qualified mechanic should always be consulted if the owner does not have sufficient knowledge to carry out repairs.

During the warranty period all service must be carried out by an Authorised Workshop for the warranty to be valid.

The following basic points should be observed if the machine is to function perfectly:

- Follow the service schedule.
- Be on the alert for sudden vibrations or abnormal noise to avoid major breakdowns.
- Always use Genuine Spare Parts
- Follow the descriptions in this manual carefully. Do not take any short cuts.

Edition	Manual	Chapter	Page
2008-05-19	Workshop Manual, Stiga Villa/Ready	1 General	3

### 1.2.1 Symbols and general warnings



#### Warning!

**This symbol indicates a risk of personal injury or damage if the instructions are not followed.**



#### Note!

This text indicates a risk of damage to the material or risk of unnecessarily complicated work if the instructions are not followed.

### 1.2.2 Warm parts

Please observe that engine and exhaust system picks up a lot of heat during use. This applies above all to the silencer of machines equipped with catalytic converter.

To avoid injuries, allow the machine to cool before any kind of repairs are made to or near parts of the engine or exhaust system.

### 1.2.3 Moving parts

The machines are all equipped with v-belt transmissions. Always stop the engine and remove the starter key before inspections or repairs are carried out.

Always use extreme caution when testing systems with moving parts to avoid injuries.

Always use Genuine Spare Parts during service work.

### 1.2.4 Lifting and blocking up

Before work under the machine, always make sure that lifting devices and jack-stands are approved for the weight. Work safe!

### 1.2.5 Cleanliness

Clean the machine before starting repairs. Dirt that penetrates into sensitive components can seriously influence the service life of the machine.

### 1.2.6 Tightening torque

Unless otherwise stated the tightening torque in the tables in the section Technical specifications must be used for the different sizes of screws. This does not refer to self-tapping screws, which are mainly used for the assembly of body parts.

### 1.2.7 Sharp edges

Watch out for sharp edges, especially when working with the mower deck. The blades can be very sharp. Always wear gloves when working with the blades.

### 1.2.8 Replacement parts

Always use Genuine Spare Parts during service work.

### 1.2.9 Inspection

Each part dismantled in conjunction with service work must be inspected. Examine for: wear, cracks, out of roundness, straightness, dents, discolouring, abnormal noise and jamming.



Edition	Manual	Chapter	Page
2008-05-19	Workshop Manual, Stiga Villa/Ready	1 General	4

## 1.3 Guarantee

### 1.3.1 Component guarantee, chassis

The guarantee is valid provided that the prescribed basic services have been carried out at an authorised service workshop during the relevant guarantee period. The services must be verified in the service book.

### 1.3.2 Exeptions

The extended warranty does not cover damage due to the following:

- Neglect by users to acquaint themselves with accompanying documentation.
- Carelessness.
- Incorrect and non-permitted use or assembly.
- The use of non-genuine spare parts.
- The use of accessories not supplied or approved by the manufacturer.

Neither does the warranty cover:

- Wearing components such as blades, belts, wheels, battery and cables.
- Normal wear.
- Engine and transmission. These are covered by the respective manufacturer's warranties, with separate terms and conditions.

The purchaser is covered by the national laws of each country. The rights to which the purchaser is entitled with the support of these laws are not restricted by this warranty.

### 1.3.3 Conditions for validity of the warranties

The fully completed warranty card must be sent to Stiga's subsidiary or distributor.

In the event of a claim, the service history must be confirmed with a copy of the service book.

Edition	Manual	Chapter	Page
2008-05-19	Workshop Manual, Stiga Villa/Ready	1 General	5

## 1.4 Unpacking and assembly

Every Stiga machine has undergone an extensive control programme before delivery. The machines are delivered as completely assembled as possible.

Thanks to this the assembly on delivery is rapid and easy.

The correct and careful assembly of the machine on delivery is a simple way of ensuring satisfied customers!

- !** Note!  
• The machine shall remain placed on the pallet during the unpacking and assembly.

### 1.4.1 Unpacking

Open up the crate and release the part as follows:

1. Check the air pressure in the tyres. The pressure is designated on the floor mat. The air pressure in the tyres is of critical importance for the performance and handling of the machine. The correct air pressure for mowing is:  
Front: 0,4 bar (6 psi)  
Rear: 1,2 bar (17 psi)  
When using some accessories it may be necessary to increase the pressure somewhat. However, the maximum permitted pressure is always 1.2 bar (17 psi).  
Too high pressure in the tyres leads to that the machine drives poor due to:
  - A small surface in contact to the ground.
  - Hard tyre = less flexibility = self cleaning characteristic deteriorate.
2. Remove the following parts from the package and put them on the floor.
  - The battery (some models).
  - The steering wheel.
  - The plastic bag, containing owners manuals, and assembly screws.

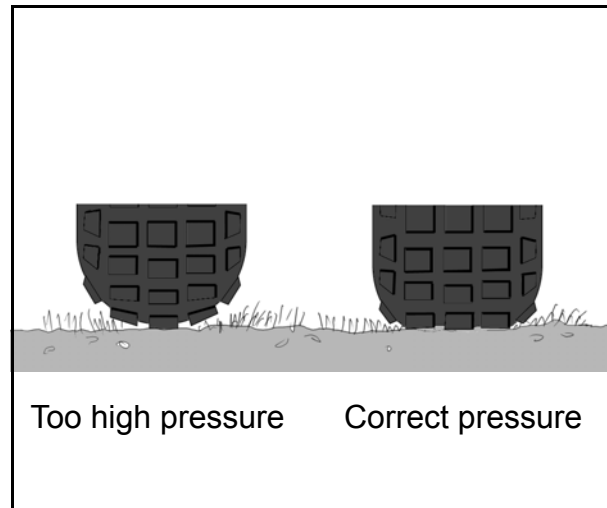

Edition	Manual	Chapter	Page
2008-05-19	Workshop Manual, Stiga Villa/Ready	1 General	6

## 1.4.2 Battery

The battery is a valve regulated type.

Depending on the battery type, load and assemble the battery, following the actual instruction below.

### Valve regulated battery

This battery needs limited maintenance. It has no electrolyte levels or plugs.



#### Warning!

**Do not wear rings, metallic bracelet, chain round the neck or similar metal objects when working with the battery. It can cause short-circuit, burns and fire.**



#### Warning!

**The battery must be fully charged before being used for the first time. The battery must always be stored fully charged. If the battery is stored while discharged, serious damage will occur.**

### Charging with the engine

The battery can be charged using the engine's generator as follows:

1. Install the battery in the machine as shown below.
2. Place the machine outdoors or install an extraction device for the exhaust fumes.
3. Start the engine according to the instructions in the user guide.
4. Allow the engine to run continuously for 45 minutes.
5. Stop the engine. The battery will now be fully charged.

### Charging using battery charger

When charging using a battery charger, a battery charger with constant voltage must be used.

The battery can be damaged if a standard type battery charger is used.

### Installation of battery

See also the respective installation manual, delivered with the machine.

After the battery is charged, remove the motor casing and install it in the machine. Connect first the red cable to plus (+) and then the black cable to minus (-).



**If the cables are disconnected/connected in the wrong order, there is a risk of a short-circuit and damage to the battery.**



**If the cables are interchanged, the generator and the battery will be damaged.**



**The engine must never be driven with the battery disconnected. There is a risk of serious damage to the generator and the electrical system.**

Edition	Manual	Chapter	Page
2008-05-19	Workshop Manual, Stiga Villa/Ready	1 General	7

### 1.4.3 Assembly

The assembly procedure shall take place in a clean, well illuminated and dry place.

Assemble the machine as follows:

#### Assembly of steering wheel

The machine is delivered with two shims, one with a thickness of 0.5 mm and one with a thickness of 1.0 mm.

In order to minimise the axial play in the steering column, the shim washers (0.5 mm) and/or (1.0 mm) must be installed on the steering column between the steering column jacket and the bracket as follows.

1. Install the steering column jacket on the steering column and secure by knocking in the tension pin approximately 1/3 of its length.
2. Pull the steering column jacket and the steering column up.
3. From the outside, check whether no washers, the 0.5 mm washer, the 1.0 mm washer or both washers can be inserted into the gap. The washer/washers must not be forced in, as there must be a little axial play.
4. Pull out the cotter pin and dismantle the steering wheel jacket.
5. Install the washer/washers in accordance with point 3 above.
6. Install the steering column jacket on the steering column and secure by knocking in the tension pin fully. Use a counterhold. Also make sure that the logo on the steering wheel is in the correct position.

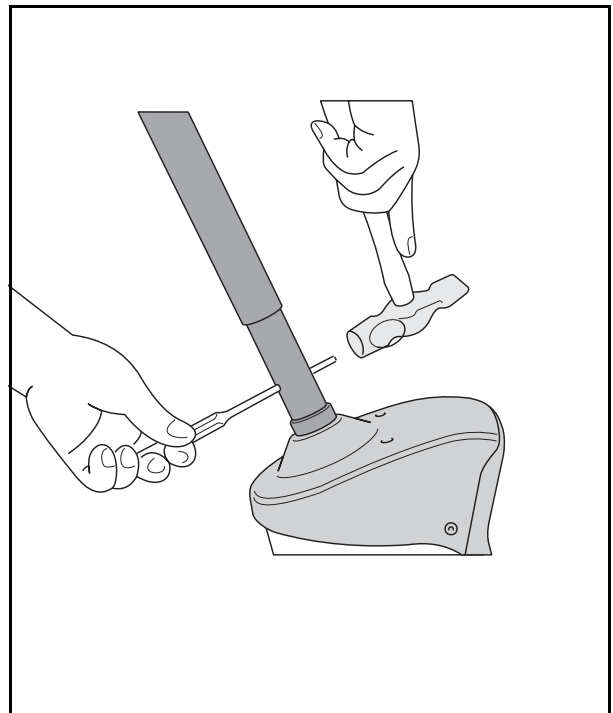



Edition	Manual	Chapter	Page
2008-05-19	Workshop Manual, Stiga Villa/Ready	1 General	8

### Assembly of seat (adjusting wings under)

Release the catch (S) and fold up the seat bracket.

**NOTE! To facilitate installation of the seat, apply a drop of oil to the four screws before screwing them into the seat.**

Install the mounting in the rear (upper) holes as follows:

1. Install the shoulder washers (F) on the screws (K).
2. Insert the screws through the slots in the bracket. Place a washer (I) between the seat and the bracket.
3. Tighten the screws in the seat. Tightening torque:  $9 \pm 1.7$  Nm.



**If the screws are tightened more than  $9 \pm 1.7$  Nm, the seat will be damaged.**

4. Check that the seat moves easily in the slots in the bracket.

Install the mounting in the front (lower) holes as follows:

1. Install the screw knobs (H) on the screws (G).
2. Install a washer (I) on each screw.
3. Insert the screws through the slots in the bracket and tighten by hand in the seat.
4. Fold the seat down and place it in the desired position.
5. Tighten the screw knobs (H) by hand.



**The screw knobs (H) and the seat will be damaged if tools are used.**

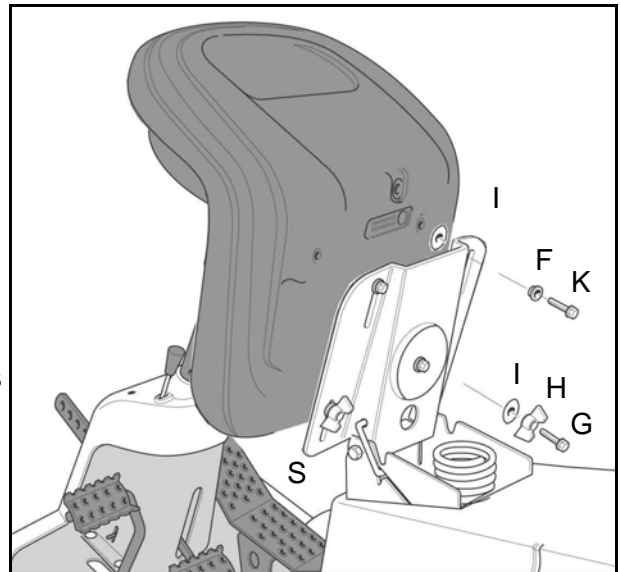

### Towing plate

Fitting according to customer requirements.

### Engine oil

Check the oil level in the engine and top up if necessary.

Edition	Manual	Chapter	Page
2008-05-19	Workshop Manual, Stiga Villa/Ready	1 General	9

## 1.4.4 Final checks

### Removing from pallet

All the above measures shall have been done with the machine standing on the pallet. Now, loosen ev. remaining attachments and roll off the machine from the pallet.

### Accessories

Fit and adjust accessories.

### Test driving



#### Warning!

**Do not drive without a work equipment (mower deck) attached.  
Risk for turning over.**

Drive the machine for a few minutes. Test all the functions. Pay special attention to the safety functions. If the machine is to be delivered with mower deck or other accessories, fit these before test driving the machine.

### HST oil

Check the oil level in the HST's expansion tank after test driving, and top up if necessary.

### Steering chain / Steering wire

Check that the steering chain / steering wire is sufficiently taut. Adjust if necessary.

### Miscellaneous

Give the machine a general inspection.

- Is the machine clean?
- Is there any oil leakage?
- Abnormal noise or rattle?

### Receipt

By filling in the guarantee certificate you guarantee that the delivery service has been correctly conducted. Remember to make sure that the customer receives all the documentation when the machine is collected / delivered.



Edition	Manual	Chapter	Page
2008-05-19	Workshop Manual, Stiga Villa/Ready	1 General	10

## 1.5 Service

Every new machine is delivered with a service book. This service book is part of the active post-market programme and shall be kept in a safe place during the entire lifetime of the machine. Hand over the service book if the machine is sold in 2:nd hand.

Service should generally be carried out at least every 50 operating hours (exception of the first service), although in accordance with the conditions below.

There are three different grades of service events. Every service event consists of a number of service points as described in the following paragraphs. Every service point has a number which refer to a describing text after the schedules.

Some service points do not coincide with the scheduled service intervals, but shall be performed in connection with a scheduled service when possible. E.g. some items shall be performed at every second service and some also between two services. These service points are described with procedure and interval in the respective "Instruction for use".

Typical service points wich not coincide with scheduled service intervals are:

- Cleaning/changing air filter in some motors.
- Change of oil in some motors.
- Valve adjustments for some motors.
- Change of spark plug in some motors.



Edition	Manual	Chapter	Page
2008-05-19	Workshop Manual, Stiga Villa/Ready	1 General	11

### 1.5.1 First Service

The first service shall be performed within 5 hours of running and includes the service points as per the table below.

This service is very important to safeguard the continuing function of the machine.

Number	Service point
1	Safety check.
2	Tyres, air pressure.
3	Engine oil, change. Machines with filter, replace it together with the oil.
4	Oil level in HST, check (Valid for machines with HST only).
5	Belt transmissions, check.
6	Steering adjustment.
21	Test driving.

### 1.5.2 Intermediate Service

The intermediate service shall be conducted between two basic services. That means 50 hours after a basic service.

Number	Service point
1	Safety check.
2	Tyres, air pressure.
3	Engine oil, change.
4	Oil level in HST, check. (Valid for machines with HST only).
6	Steering adjustment.
8	Air filter, cleaning.
11	Cooling fins, clean.
12	Lubrication

The intermediate service is not as extensive as the Basic Service and can therefore be conducted by the customer, or by an authorised Service Workshop. Regardless of who conducts the service, it must be documented in the service book.



Edition	Manual	Chapter	Page
2008-05-19	Workshop Manual, Stiga Villa/Ready	1 General	12

### 1.5.3 Basic Service

The basic service shall be conducted every 100 hours or once every year, whichever first occurs.

The Basic Service must always be conducted by an authorized Service Workshop, and documented with a stamp in the service book.

Number	Service item
1	Safety check
2	Tires, air pressure
3	Engine oil, change. Machines with filter, replace it together with the oil.
4	Oil in HST, check.
5	Belt transmissions, check
6	Steering adjustment
8	Air filter for engine, clean/replace

Number	Service item
10	Cooling fins, clean
11	Spark plug, check/replace
13	Transmission, check
14	Speed check
15	Bearing boxes, check**
16	Exhaust system, check*
17	Electrical system, check*
18	Mower deck, check**
19	Blades, check**
20	Power take-off, check
21	Control check
22	Valve play***
23	Test driving

\*) See also "Safety check".

\*\*\*) See also the mower deck manual.

\*\*\*) See the motor manual.



Edition	Manual	Chapter	Page
2008-05-19	Workshop Manual, Stiga Villa/Ready	1 General	13

## 1.5.4 Description of service points

### 1. Safety check

Check the safety functions. It is often appropriate to do this check in conjunction with test driving. The following items shall be checked at all machines:

- No leakage on fuel lines and connections.
- No mechanical damages to the electrical cables. All insulation intact.
- The muffler shall be undamaged and its screws tightened. No exhaust leakage in connections.

The electrical check items at the respective machine up to model 2004 are listed in the tables below. For models 2005 and up, see the respective "Instructions for use".

#### Models with manual gearbox

Test	Status	Action	Result
1	PTO activated. No gear activated.	Turn the key and make a start attempt.	Motor shall not start.
2	PTO not activated. A gear is activated.	Turn the key and make a start attempt.	Motor shall not start.
3	Motor running. PTO activated.	Operator rises from the seat.	Motor shall stop.
4	Motor running. A gear activated.	Operator rises from the seat.	Motor shall stop.
5	Motor running.	Disconnect cable from the shut off valve.	Motor shall stop after a few minutes.

#### HST models

Test	Status	Action	Result
1	Brake pedal not pressed. PTO not activated.	Turn the key and make a start attempt.	Motor shall not start.
2	Brake pedal pressed. PTO activated.	Turn the key and make a start attempt.	Motor shall not start.
3	Motor running. PTO activated.	Operator rises from the seat.	Motor shall stop.
4	Motor running.	Disconnect cable from the shut off valve.	Motor shall stop after a few minutes.



Edition	Manual	Chapter	Page
2008-05-19	Workshop Manual, Stiga Villa/Ready	1 General	14

## 2 Tyres, air pressure

Check the air pressure. Adjust if necessary. The recommended air pressure is designated at the floor mat.

## 3 Engine oil and oil filter

See "Motors" at page 18. and the "Instructions for use", delivered with the machine, see "Instructions for use" at page 19. See also the engine manufacturer manual.

## 4 Oil, HST

See the "Instructions for use", delivered with the machine.

## 5 Belt transmissions, check

Check the condition of all the belts and belt tensioners.

## 6 Steering, adjustment

See section 3.

## 7 Not applicable

## 8 Engine air filter

See the "Instructions for use", delivered with the machine. See also the engine manufacturer manual.

## 9 Not applicable

## 10 Cooling fins

Remove protective covers from the engine and cleans between cooling fins. Use a brush and compressed air. See also the engine manufacturer manual.

## 11 Spark plug

Remove the spark plug and clean it or replace if necessary. See also the engine manufacturer manual.

## 12 Lubrication

Lubricate the 5 nipples and all moving parts such as wires and levers. See section 2.

## 13 Transmission

Listen for abnormal noise. Manual models: Check that the drive function works properly at all gears. Adjust if required.

## 14 Speed check

Check that the speed corresponds to the specified value.

## 15 Bearing boxes

Listen for abnormal noise from the bearings. Check that there are no wear, play or seizure.

## 16 Exhaust system

Check that there are no cracks, leakage or other damages. Check the attachment devices. See also the engine manufacturer manual.

## 17 Electrical system

Check that there are no damaged cables, contacts or other devices. Check that all cables are properly secured to the chassis and with cable holders. Check that there is no friction between cables and chassis, which can result in cable damage and short circuit.

Edition	Manual	Chapter	Page
2008-05-19	Workshop Manual, Stiga Villa/Ready	1 General	15

## 18 Mower deck



### Warning!

**The blades are sharp. Always wear gloves when working with the blades to avoid injury.**

Check if there are collision damages or wear at the deck body and painting. Align, repair and touch up the painting as required.

Check the tightening of the bearing boxes screws and tighten.

Rotate the blades and check the the shafts are correct, not bent, no abnormal bearing noise and no plays.

Check the belts and their tensions, see section 4.

Check that the lifting mechanism moves evenly, not jammed and no play and that it locks in desired position.

Check the electrical function of the electrical mower lifter (if applicable).

Check the plastic guide bar between the blades. Replace if required.

## 19 Blades



### Warning!

**The blades are sharp. Always wear gloves when working with the blades to avoid injury.**

Check that the blades are sharp. Replace if necessary.

## 20 Power take-off (PTO)

Check that the magnetic clutch (if applicable) engage the work equipment rotation in the desired time and that it not slips during normal load. Replace the clutch if necessary.

Check that the power take-off belt (if applicable) engage the work equipment rotation in the desired time and that it not slips during normal load. Adjust if necessary. See section 5.

Check that the power take-off brake (if applicable) brakes the rotation movement in the desired time. Adjust if necessary. See section 5.

## 21 Control check

Check that all controls function properly, that there are no jammings or excessive plays. Adjust if nesaccary. See section 6.

## 22 Valve play

See the engine manual regarding procedure and interval.

## 23 Test driving

Drive the machine during a few minutes and make the following attentions in different speeds and turnings in right and left. Check that all functions work evenly and proper and without any abnormal noise.

- Brake function
- Clutch function
- Power take-off
- Steering

Check that there are no abnormal vibrations.





Edition	Manual	Chapter	Page
2008-05-19	Workshop Manual, Stiga Villa/Ready	1 General	16

## 1.6 Technical specifications

### 1.6.1 General tightening torque

Unless otherwise stated, the following tightening torque are applicable for screws and nuts on the machine:

#### Tightening torques

Thread	Torque
M5	5 Nm
M6	9 Nm
M8	22 Nm
M10	45 Nm

Edition	Manual	Chapter	Page
2008-05-19	Workshop Manual, Stiga Villa/Ready	2 Chassis and Body	1

## 2 Chassis and body

### Contents in this chapter

<b>2.1 Lifting mechanism, manual .....</b>	<b>2</b>	<b>2.2 Lubrication chassis .....</b>	<b>8</b>
2.1.1 General.....	2	2.2.1 Steering pivot pins and beam pivot.....	8
2.1.2 Description.....	2	2.2.2 Control wires.....	8
2.1.3 Dismantling.....	2	2.2.3 Tensioning arms .....	9
2.1.4 Repair of lifting lock .....	6	2.2.4 Steering chain.....	9
2.1.5 Assembly .....	6	2.2.5 Bearings.....	9

### General

To facilitate the driving, handling of work equipment and to make it comfortable for the driver, the machines are equipped with a various number of aid equipments. These equipments are mainly the same for all the machines covered by this manual, but in some cases configured in different ways. Where divergences occur between the machines, particular instructions are given for each particular equipment.

This chapter gives a brief description of the equipments and describes their repair and replacements.

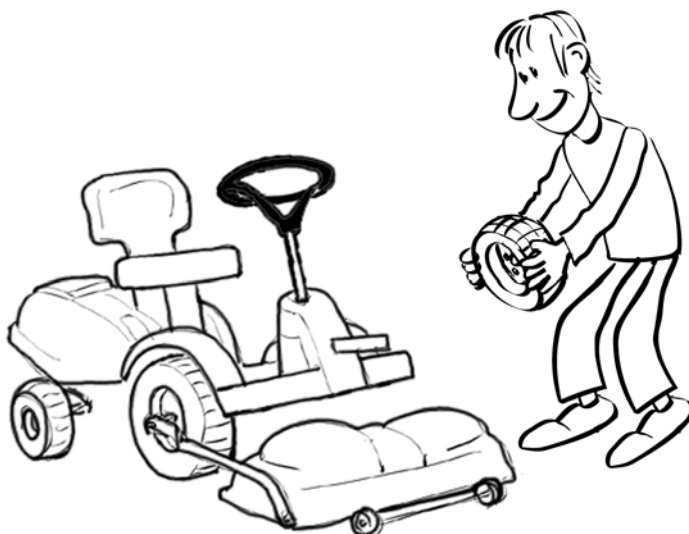

Edition	Manual	Chapter	Page
2008-05-19	Workshop Manual, Stiga Villa/Ready	2 Chassis and Body	2

## 2.1 Lifting mechanism, manual

### 2.1.1 Description

The work equipment lifting arm is automatic locked in elevated position by pressing down the lifting pedal. Next time the pedal is pressed, the mechanism will release and the arm drops down.

The locking function is created in the lifting lock. The principle is described below and shown in the figure.

- A. Locked in lifted position by the ratchet (C).
- B. Unlocked. Ratchet (C) is released.
- C. Ratchet which is tilted by the pin (D) every time the pedal is pressed down.

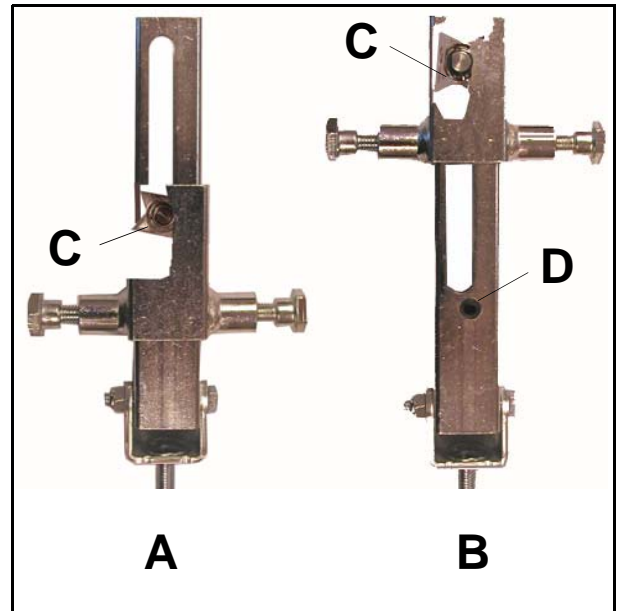

### 2.1.2 Dismantling

To dismantle the lifting lock it is normally necessary to dismantle the steering console. Nevertheless, it is possible for a skilful person to dismantle the lifting lock without releasing the steering console.

The dismantling is performed as follows:

1. Dismantle the steering wheel by tapping out the pin.

If applicable, observe the spacers and the location when disassembly the steering wheel.

See section 1.

Edition	Manual	Chapter	Page
2008-05-19	Workshop Manual, Stiga Villa/Ready	2 Chassis and Body	3

2. Remove the screws for the top cover.

If applicable, remove also the following:

- The bullet from the throttle handle by twisting and pulling it simultaneously.
- The ignition switch nut. To avoid damage at the plastic cover, use a 22 mm ring wrench.
- The cutting height switch by pressing its locking tabs at the underside.

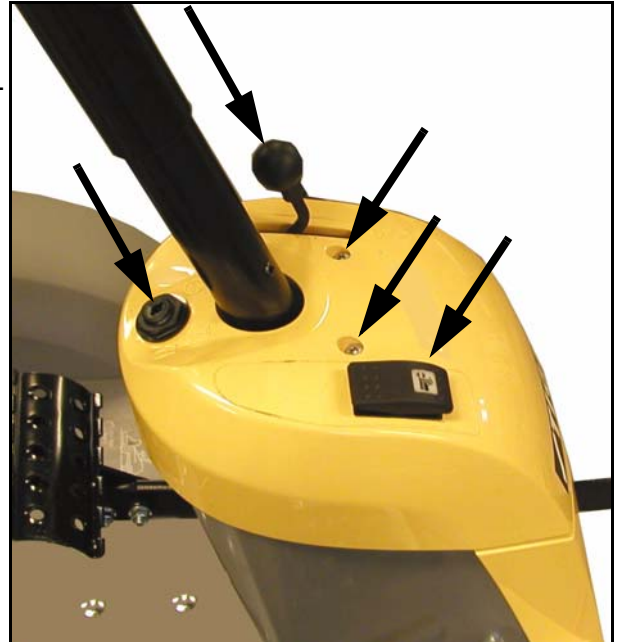

3. Dismantle the front cover by unscrewing the two screws at the under side.

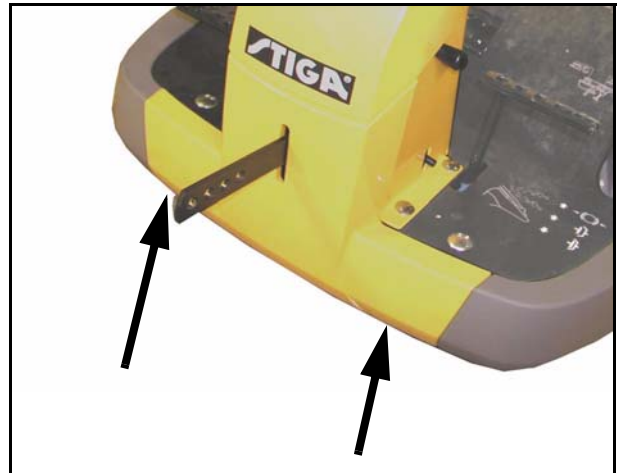

4. Unhook the return spring.

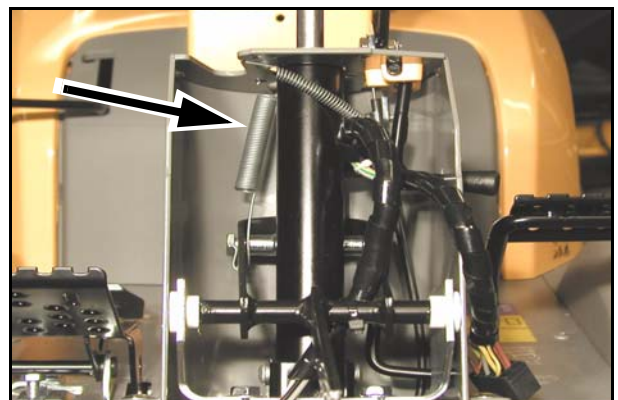

Edition	Manual	Chapter	Page
2008-05-19	Workshop Manual, Stiga Villa/Ready	2 Chassis and Body	4

5. Dismantle the lifting pedal located on the lifting arm.

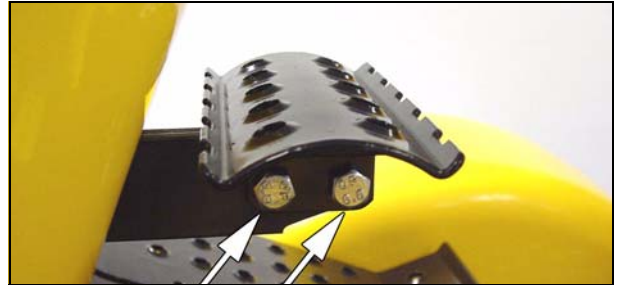

6. Loosen the throttle control as follows:  
1. Loosen the lever.  
2. Observe where the wire conductor is fitted to reassemble in the same position.

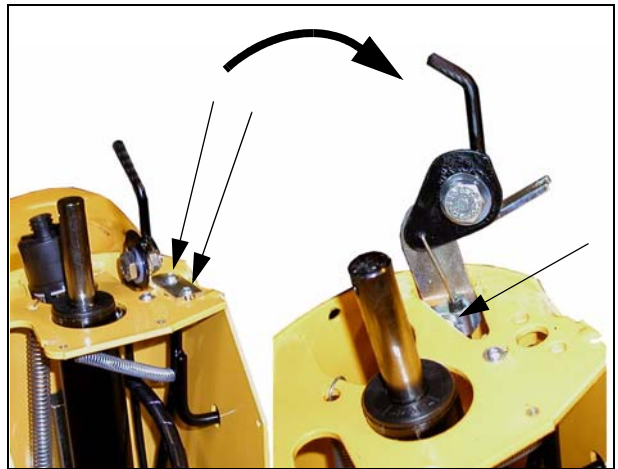

7. Remove the screws that hold the steering console at the floor plate, and lift off the steering console.

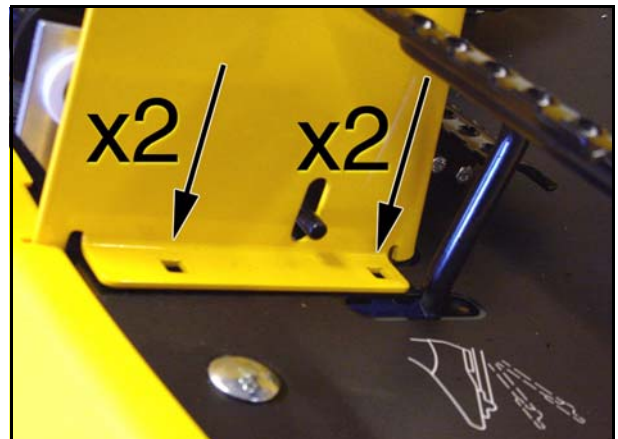

8. Remove the screws that hold the lifting fork at the lifting lock.

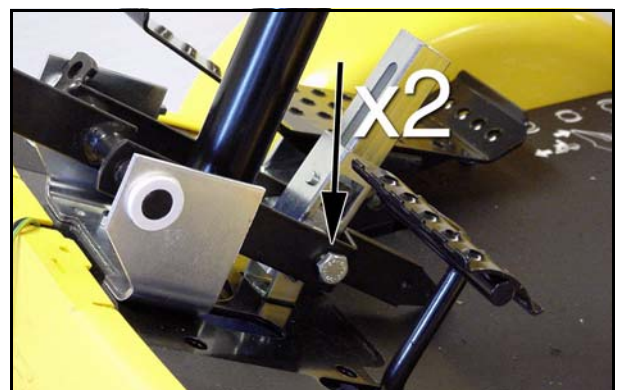

Edition	Manual	Chapter	Page
2008-05-19	Workshop Manual, Stiga Villa/Ready	2 Chassis and Body	5

9. Remove the nut that holds the lifting lock on the underside of the floor plate, and remove the lifting lock.

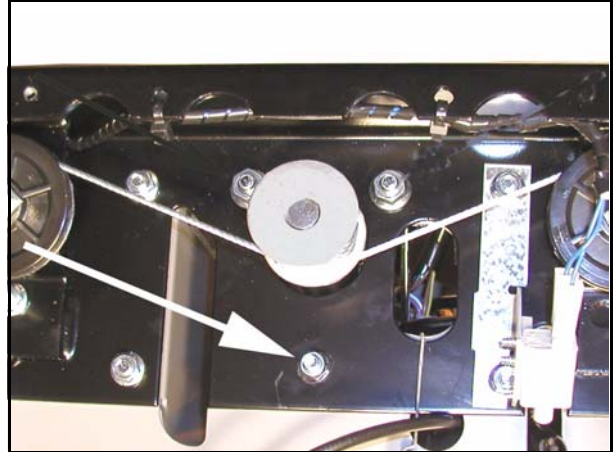

10. Carefully dismantle the left bearing in the support with a screwdriver.

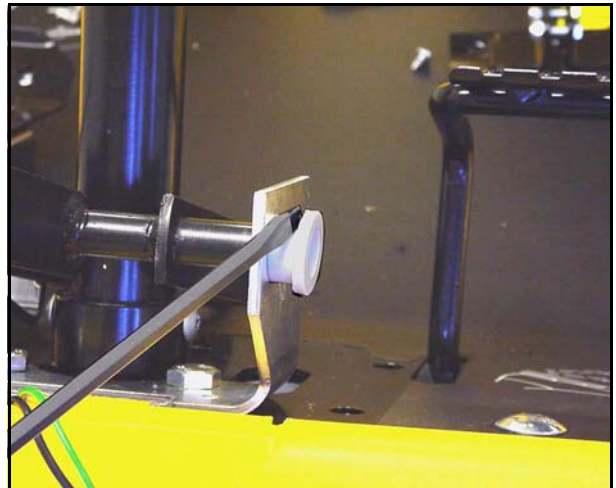

11. Remove the lifting fork from the support.

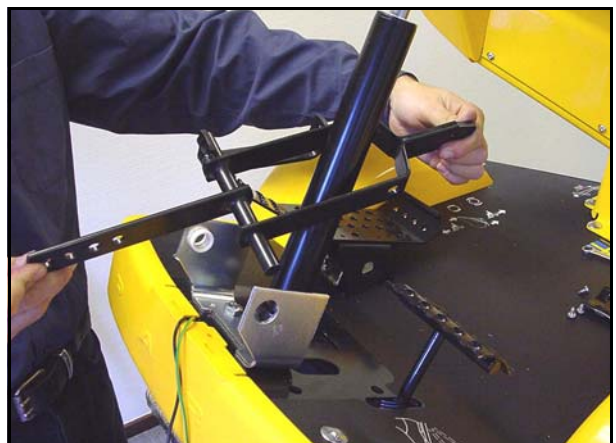

Edition	Manual	Chapter	Page
2008-05-19	Workshop Manual, Stiga Villa/Ready	2 Chassis and Body	6

### 2.1.3 Repair of lifting lock

The lifting lock can be purchased as a complete spare part.

The parts can be lubricated with a thin lubricant, e.g. silicon spray, 5-56, WD40, or the like, if the lock jams.

- ! **Note!**  
Viscous lubricant such as consistent grease must not be used.

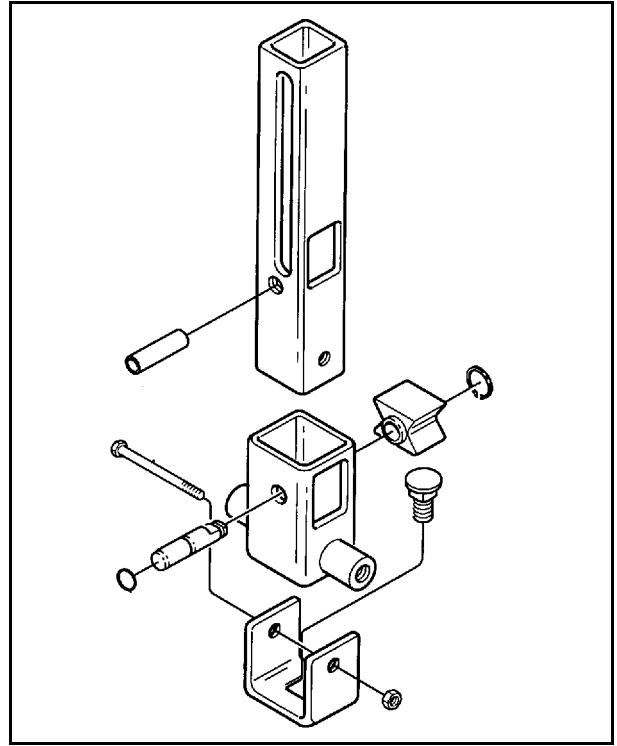

### 2.1.4 Assembly

Assemble in reverse order.  
Check that the accessory lifter functions as intended by repeatedly lifting and lowering it.

- ! **Note!**  
Pay attention to the following notes during the assembly:

- Apply a thin layer of universal grease to the plastic bushings at the lifter arm.
- It does not matter how the lifting lock is fitted since it is symmetrical.

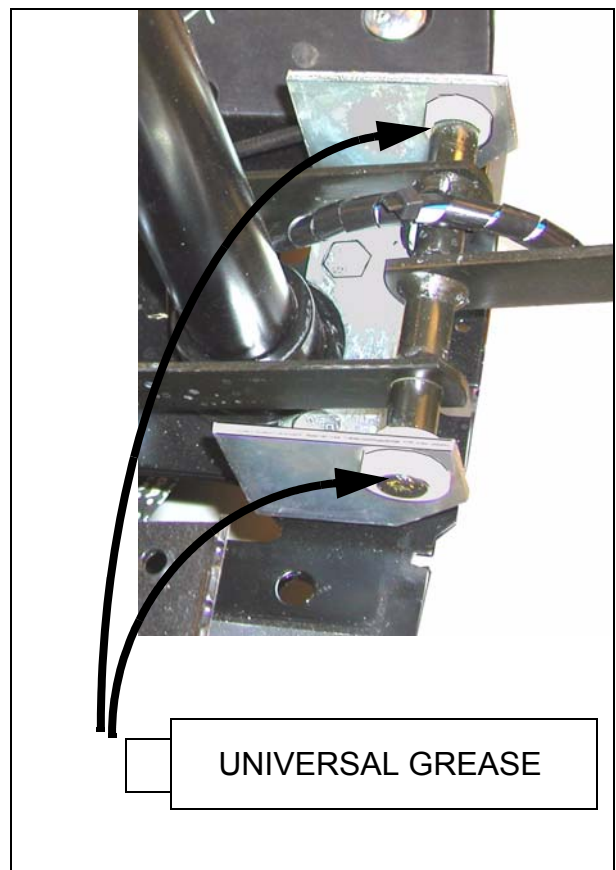

Edition	Manual	Chapter	Page
2008-05-19	Workshop Manual, Stiga Villa/Ready	2 Chassis and Body	7

- C. When fitting the throttle control, install the wire conduit as observed at the dismantling.
- D. Fit the top cover before the consol screws are tightened.  
The consol is aligned against the top cover.
- E. If applicable, observe the spacers and the location when reassembly the steering wheel.  
See section 1.

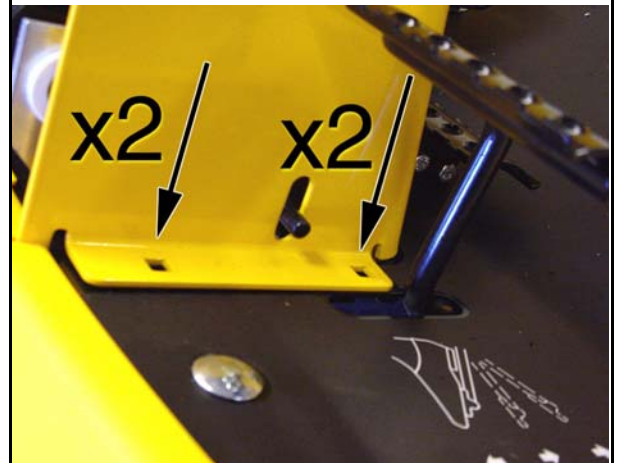
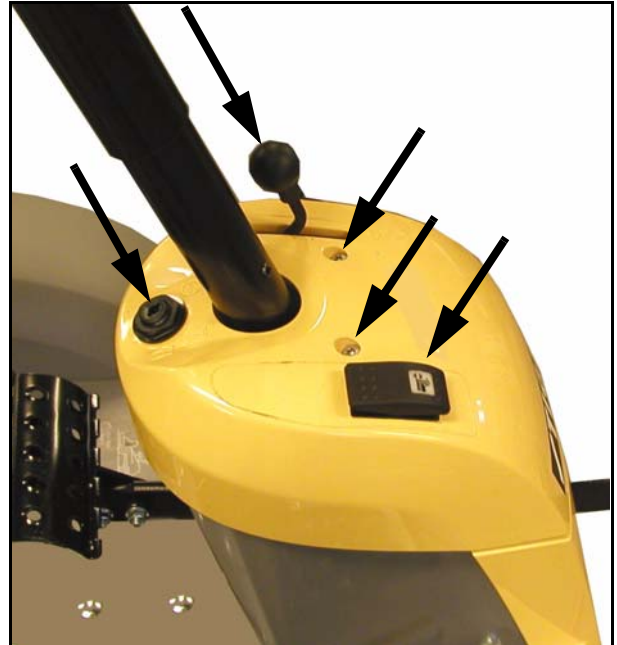



Edition	Manual	Chapter	Page
2008-05-19	Workshop Manual, Stiga Villa/Ready	2 Chassis and Body	8

## 2.2 Lubrication chassis

All moving parts shall be lubricated once per season, although at least every 50 operating hours.

- ! Note!**  
Lubrication is equally important for a machine that is only used for a few hours per year.
- ! Note!**  
The lubricant provides not only protection from wear but also from rust.
- ! Note!**  
The machine should always be lubricated before prolonged storage.

### 2.2.1 Steering pivot pins and beam pivot

Use a grease gun, filled with universal grease and lubricate the steering pivot pins (A) and the beam pivot (B). Lubricate until grease emerges.

- ! Note!**  
To lubricate the beam pivot (B) it might be necessary to dismount the towing hitch.

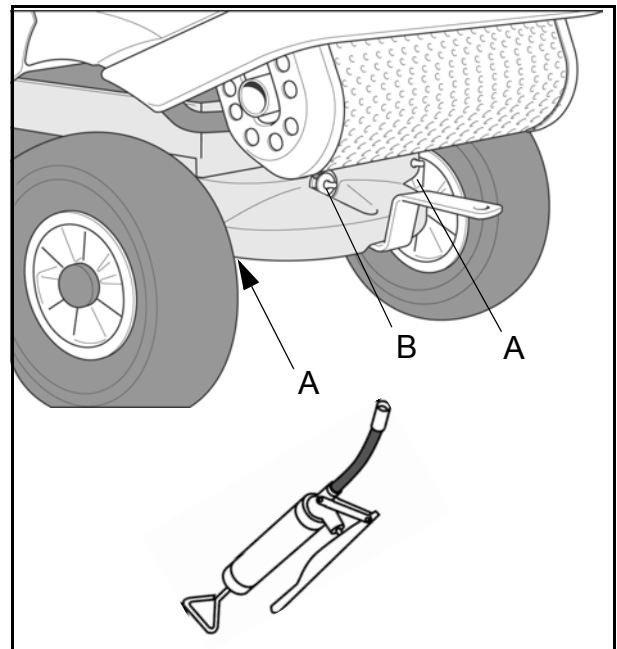

### 2.2.2 Implement mountings

Lubricate the lubricating cup for the mountings using a grease gun until grease penetrates along side the shaft.

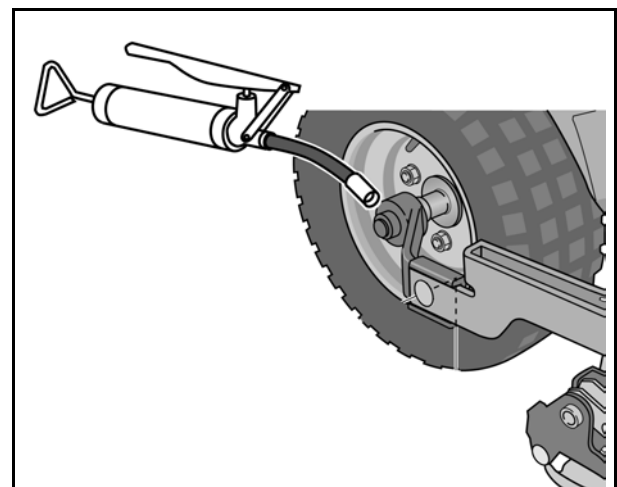

Edition	Manual	Chapter	Page
2008-05-19	Workshop Manual, Stiga Villa/Ready	2 Chassis and Body	9

### 2.2.3 Control wires

Drop a little universal oil or lubricating spray in the ends of the control wires two or three times a year.

This procedure must be carried out by two persons. One lubricates and one activates the lever



**Note!**  
Wires on machines used in freezing conditions should not be lubricated with engine oil since this can lead to the control cables seizing in the cold. The wires on such machines should be lubricated with a fluent, strongly penetrating lubricant, e.g. 5-56 or WD40.

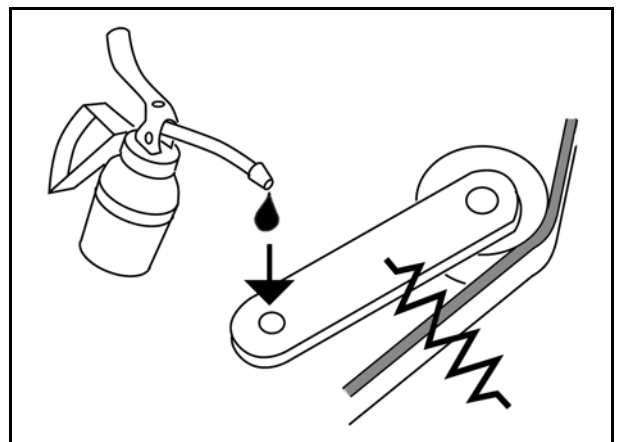
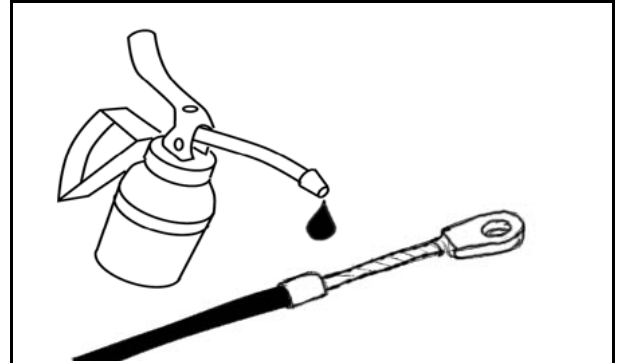

### 2.2.4 Tensioning arms

Lubricate the bearing points with an oil can when each control is activated. Ideally carried out by two persons.

### 2.2.5 Steering chain

The steering chain must be lubricated with chain spray two or three times per season. If the chains are heavily fouled: dismantle the chains and wash them. Refit and lubricate them.

### 2.2.6 Bearings

Plastic bearings, e.g. the brake pedal bearing, hydrogear pedal bearing and steering-column bearing, must be lubricated with grease or lubricating spray at least once per year.

Edition	Manual	Chapter	Page
2008-05-19	Workshop Manual, Stiga Villa/Ready	3 Steering	1

## 3 Steering

### Contents in this chapter

<b>3.1 Steering wire/chain.....</b>	<b>2</b>	<b>3.2 Bearings, steering shaft .....</b>	<b>6</b>
3.1.1 Description .....	2	3.2.1 Replacement of sliding	
3.1.2 Dismantling.....	2	bearings.....	6
3.1.3 Assembly .....	3		
3.1.4 Steering pulleys.....	5		
3.1.5 Adjusting the steering wire .....	5		

### General

The Villa and Ready machines are equipped with a mechanical steering system, working with wires or chains, depending on the model.

This chapter contains a brief description of the function and describes repair, replacements and adjustments of stressed parts of the steering system.

This chapter is valid for the actual machines where the actual system occur.



Edition	Manual	Chapter	Page
2008-05-19	Workshop Manual, Stiga Villa/Ready	3 Steering	2

## 3.1 Steering wire/chain

### 3.1.1 Description

There are two configurations regarding to transmit the steering power from the steering wheel to the rear wheels:

- **Wire**; One single wire with a defined location at the drive pulley.
- **Chain/wire**; Two wires, left and right, fitted to a chain which is connected to the steering pulley.

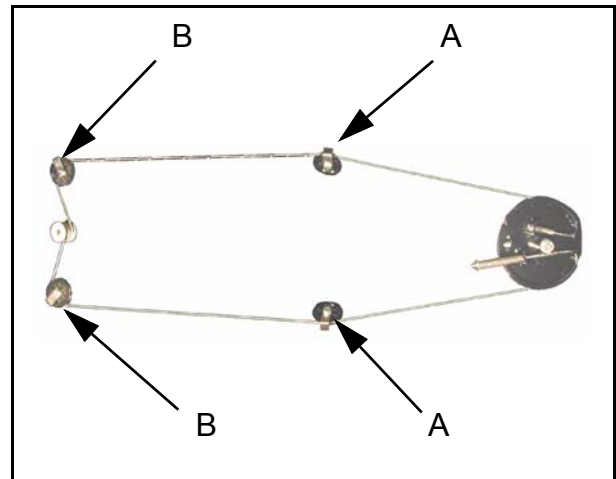

### 3.1.2 Dismantling

#### 1. Wire:

Remove the four steering pulleys (A and B). Use a 15 mm and a 17 mm wrench.

#### Chain/Wire:

Remove the two steering pulleys (A). Use a 15 mm and a 17 mm wrench.

2. Remove the nut and screw, holding the wire ends (C). Use a 13 mm wrench and a pliers to hold the wire ends.

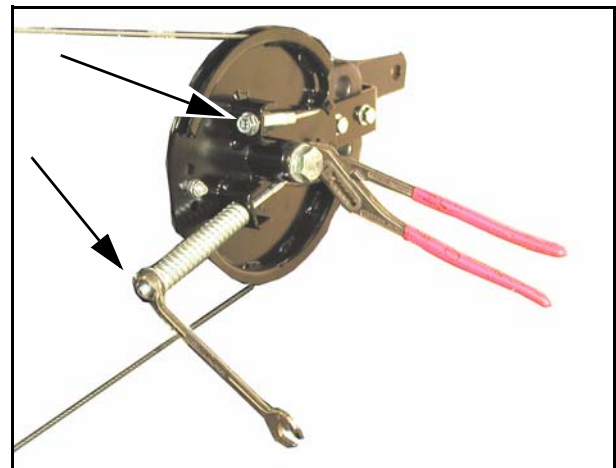

3. Remove the wire from the machine.

#### Wire:

Pull out the wire rivet from the steering pulley and release the wire.

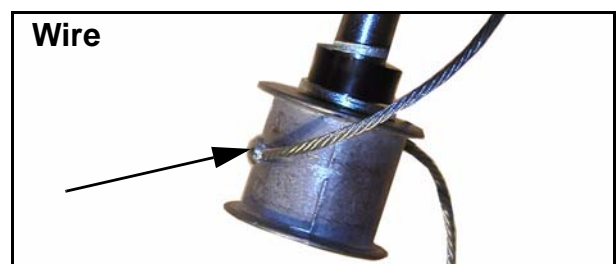

#### Chain/Wire:

Open the chain locks and release the wires from the chain.

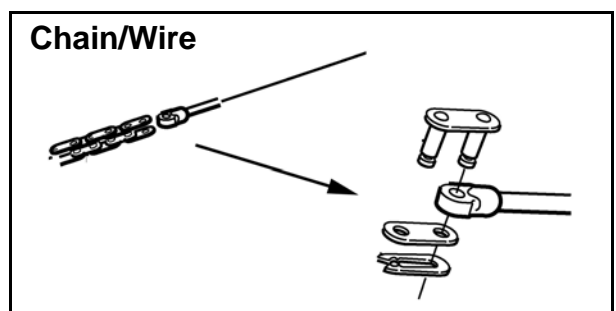

Edition	Manual	Chapter	Page
2008-05-19	Workshop Manual, Stiga Villa/Ready	3 Steering	3

### 3.1.3 Assembly

#### One single wire

- Assemble the left wire part into the two left steering pulleys (A and B). Fit the pulleys into their respective place.  
See "3.1.4 Steering pulleys".
- Locate the wire in the recess (C) in the steering disc and fasten with the screw. Use a 13 mm wrench and a pliers to hold the wire ends.
- Turn the steering wheel until the wire rivet hole is facing backwards and push in the rivet.
- Turn carefully the steering wheel 1,5 turn to the left and simultaneously check that the wire winds up correctly upwards on the drive pulley.  
Keep the left wire part stretched by blocking or holding the rear wheels.
- Assemble the right wire part into the two right steering pulleys (A and B). Fit the pulleys into their respective place.  
See "3.1.4 Steering pulleys".
- Turn the wire 1,5 turns to the right on the drive pulley. Keep the wire stretched.
- Keep the wire stretched and locate the wire in the recess (D) in the steering disc and fasten with the parts below. Use a 13 mm wrench and a pliers to hold the wire ends.
  - Spring
  - Washer
  - M8 self locking nut

Adjust the wire.

See "3.1.5 Adjusting the steering wire".

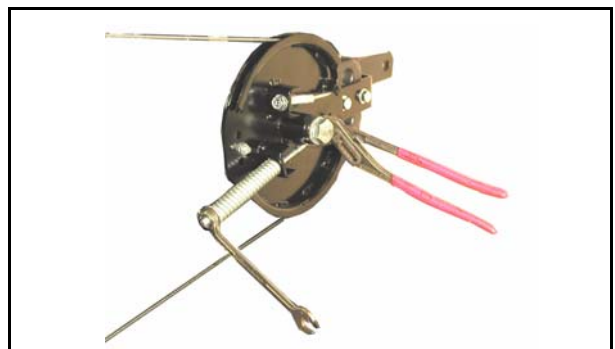
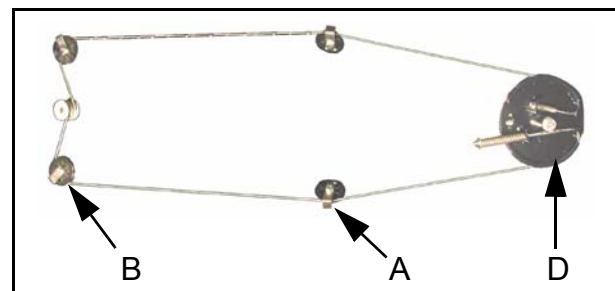
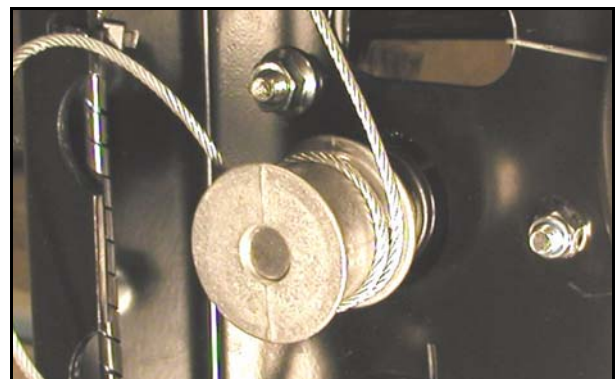
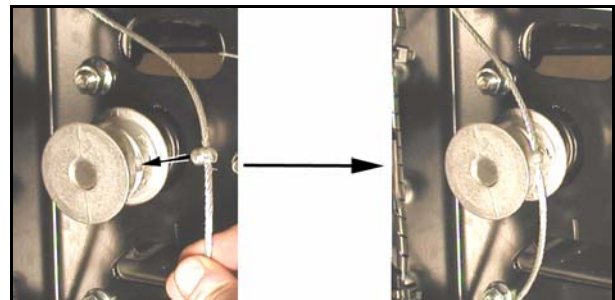
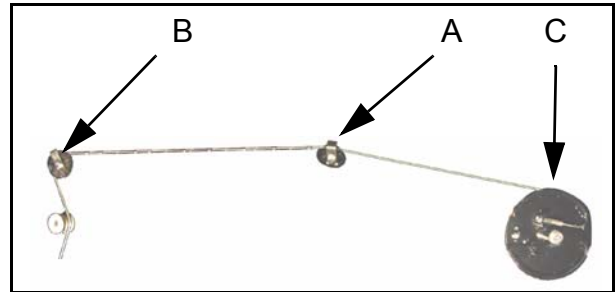

Edition	Manual	Chapter	Page
2008-05-19	Workshop Manual, Stiga Villa/Ready	3 Steering	4

### Chain/Wire

1. Assemble the left wire part into the left steering pulley (AL). Fit the pulley into place. See “3.1.4 Steering pulleys”.
2. Locate the wire in the recess (C) in the steering disc and fasten with the screw. Use a 13 mm wrench and a pliers to hold the wire end.
3. Assemble the right wire part into the right steering pulley (AR). Fit the pulley into place. See “3.1.4 Steering pulleys”.
4. Connect the wires to the chain with the chain locks.
5. Stretched up the wire and locate it in the recess (D) in the steering disc and fasten with the parts below. Use a 13 mm wrench and a pliers to hold the wire ends.
  - Spring
  - Washer
  - M8 self locking nut

Adjust the wire.  
See “3.1.5 Adjusting the steering wire”.

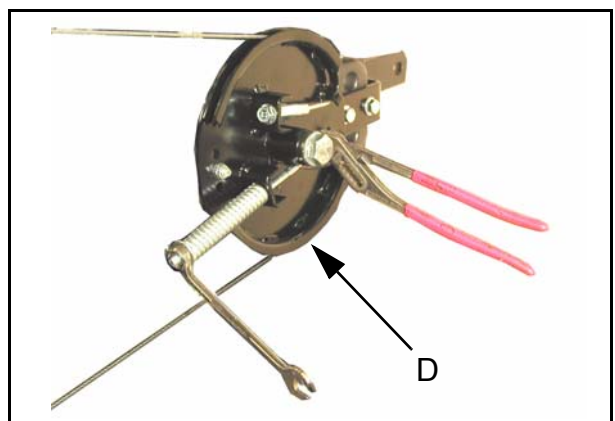
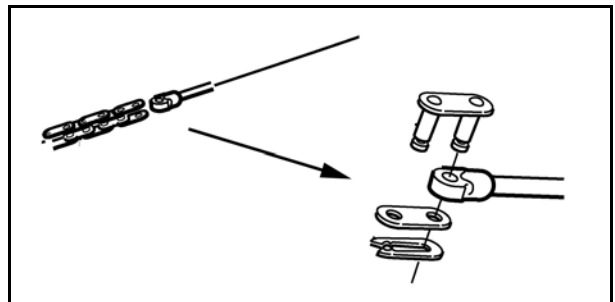
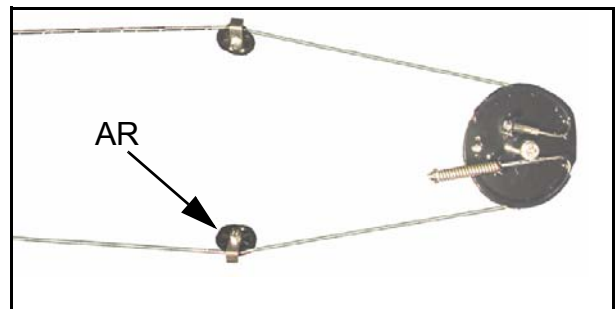
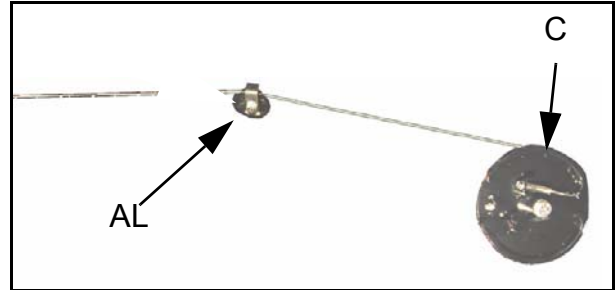

Edition	Manual	Chapter	Page
2008-05-19	Workshop Manual, Stiga Villa/Ready	3 Steering	5

### 3.1.4 Steering pulleys

Every single steering pulley consists of the following parts:

- A. Screw
- B. Cable holder
- C. Bushing
- D. Steering pulley
- E. Part of the frame
- F. Nut

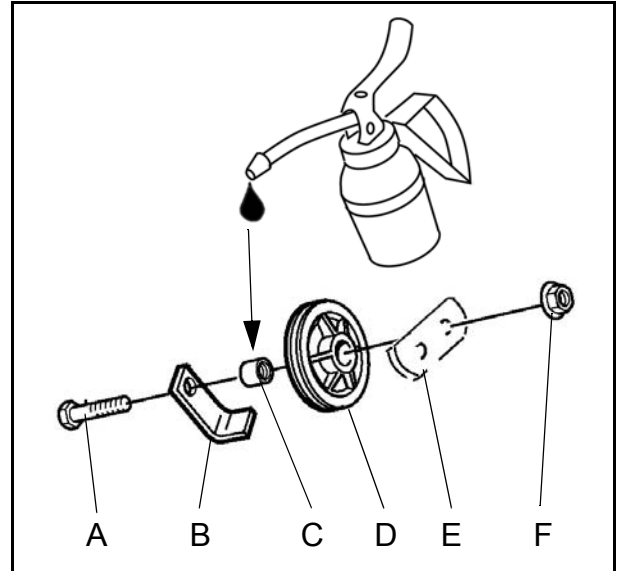

#### Assembly instructions:

- Check the wear, specially of the steering pulley, and replace defective parts.
- Apply a thin layer of machine oil to the bushing (C).
- The cable holder (B) shall be centered according to the wire, i.e. the angles in the figure shall be equal.

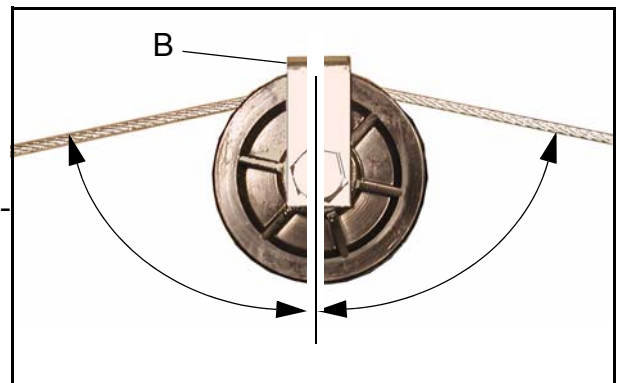

### 3.1.5 Adjusting the steering wire

Screw the nut and compress the spring until its length is 108 mm. Hold the wire with a pliers.

Turn the wheels fully out in both directions. Check that there is no abnormal noise or abnormal resistance.

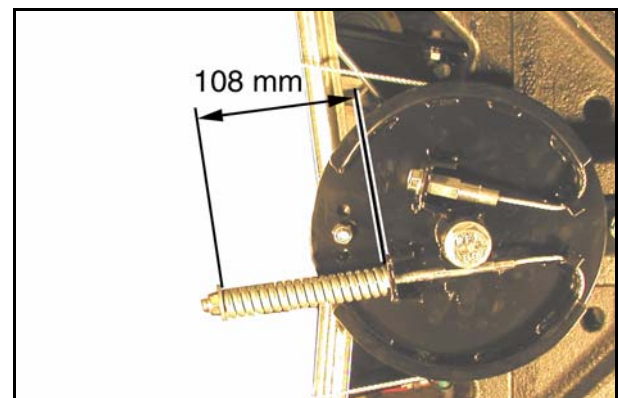

Edition	Manual	Chapter	Page
2008-05-19	Workshop Manual, Stiga Villa/Ready	3 Steering	6

## 3.2 Bearings, steering shaft

The steering shaft bearings consist of two sliding bearings of the composite type (A and B).

### 3.2.1 Replacement of sliding bearings

1. Remove the steering wire or wires. See "3.1.2 Dismantling".
2. Remove the steering wheel. See section 1.
3. If the machine is equipped with chain and wire, release the chain from the sprocket.
4. Pull out the steering rod (F) downwards. Don't remove the washers and spacer (C, D and E).
5. Replace the two bearings (A and B).
6. Assemble the steering rod (F) with its washers and spacer (C, D and E).
7. Assemble the steering wheel. See section 1.
8. Instructions for the chain, if applicable:
  - A. Apply a mark with a marking pencil at the middle link of the chain (ev. there already is a mark).
  - B. Turn the steering wheel to straight forward position, i.e. the logo shall be correct readable from the operators position.
  - C. Connect the chain to the sprocket with the mark (G) backwards.
9. Assemble the steering wire or wires. See "3.1.3 Assembly".

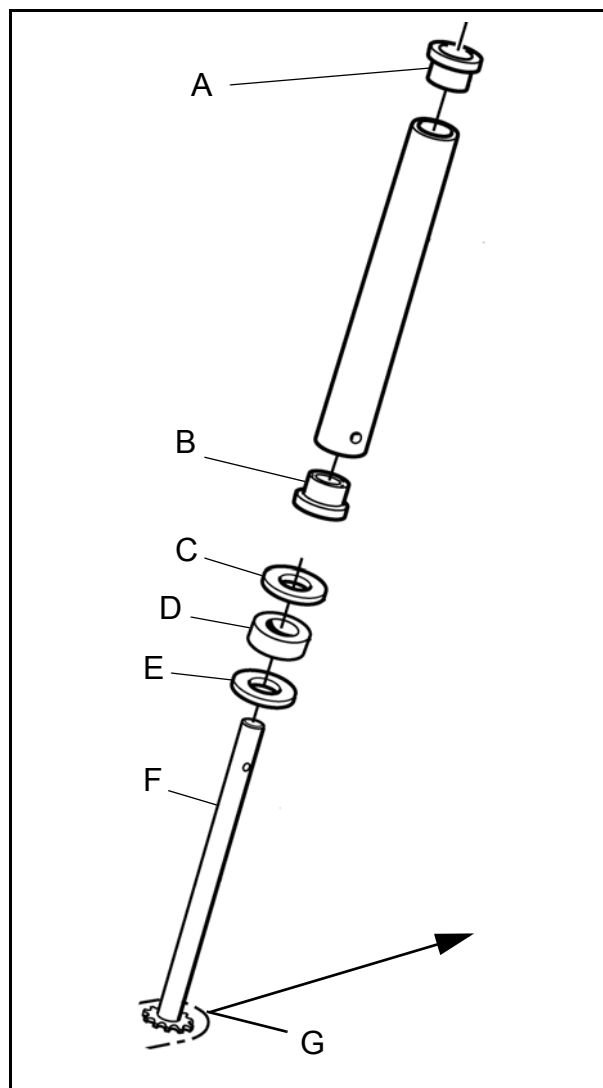



Edition	Manual	Chapter	Page
2008-05-19	Workshop Manual, Stiga Villa/Ready	4 Hydraulic System	1

## 4 Hydraulic system

### Contents in this chapter

4.1 Safety .....	2
4.2 Description .....	2
4.3 Repair .....	2
4.4 HST oil .....	3
4.4.1 General.....	3
4.4.2 Oil filling.....	3

### General

The engine power in Villa and Ready machines are transferred by a 5 gear gearbox alternatively a stepless hydrostatic transmission (HST) to the front wheels. The steering is performed by the rear wheels.

This chapter contains a brief description of the hydrostatic transmission and the oil filling procedure. Other measures are not applicable.

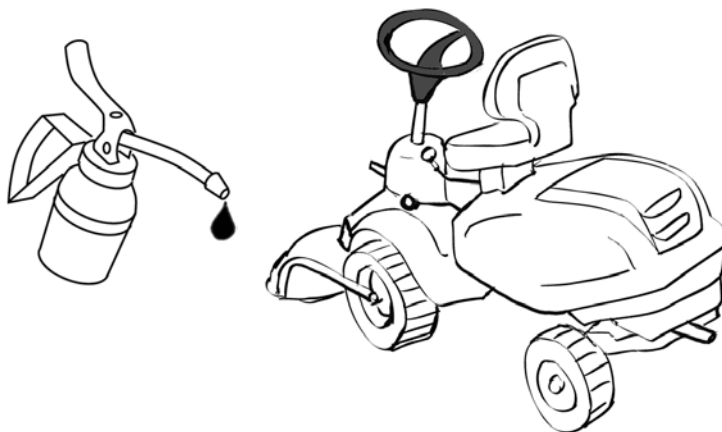



Edition	Manual	Chapter	Page
2008-05-19	Workshop Manual, Stiga Villa/Ready	4 Hydraulic System	2

## 4.1 Safety

**Cleanliness is mandatory at all works with the hydraulic system. Foreign substances and contaminations will jeopardize the function and reliability of the system.**

## 4.2 Description

The hydrostatic transmission (HST) consists of a hydraulic pump and a hydraulic motor.

The hydraulic pump is mechanic connected to the drive belt.

The power from the pump is transmitted to the motor by an oil flow, i.e. the transmission is hydraulic.

The hydraulic motor is mechanic connected to the wheel shaft.

Since both the oil flow and the flow direction is controlled by the drive pedal, the machine can move both forwards and backwards with a stepless gear ratio.

## 4.3 Repair

Since trouble with the HST is very unusually, there is no need for any repair instructions in this book.

However, in some cases oil leakage can occur. Therefor, the oil filling procedure is described below.

Should major repair to the HST be needed, please refer to the service provided of the transmission manufacturer.

Edition	Manual	Chapter	Page
2008-05-19	Workshop Manual, Stiga Villa/Ready	4 Hydraulic System	3

## 4.4 HST oil

### 4.4.1 General

The HST casing is a sealed unit, which normally not need any service. Oil filling is recommended only if any of the cases or both cases below are valid:

- There is a visible oil leakage.
- Drive problems.

### 4.4.2 Oil filling

**! Note!**  
It may be difficult to remove the entire oil plug intact. It is recommended to have a new plug available before starting the oil filling.

1. Lift the machine.
2. Remove the oil plug.  
The oil plug also works as a ventilation valve. The oil plug consists of rubber and fits rather hard in the housing hole. Use a long pointed chisel to work up the plug. Eventually, loosen the HST in the frame and lower it for better access.
3. Check the oil level. Use a suitably bent steel wire or similar.  
The level shall reach up to just under the lower part of the plug.
4. If necessary, top up with new oil.  
Use oil SAE 10W-40 or SAE 5W-50.  
Elongate the discharge of an oil can with a plastic hose of suitable length and diameter. Put the other end into the HST oil hole and pump until the oil flows over.
5. Fit a new oil plug and assemble in reverse order.

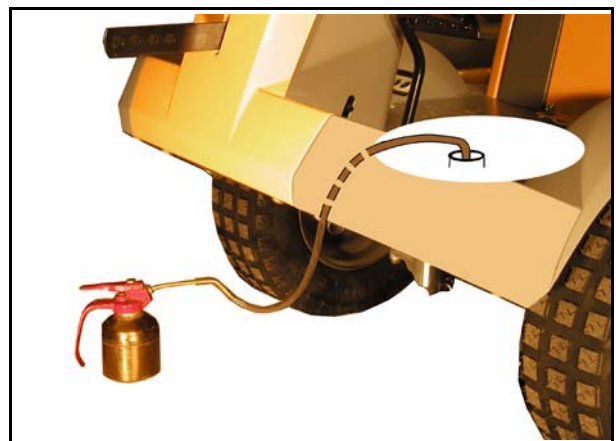
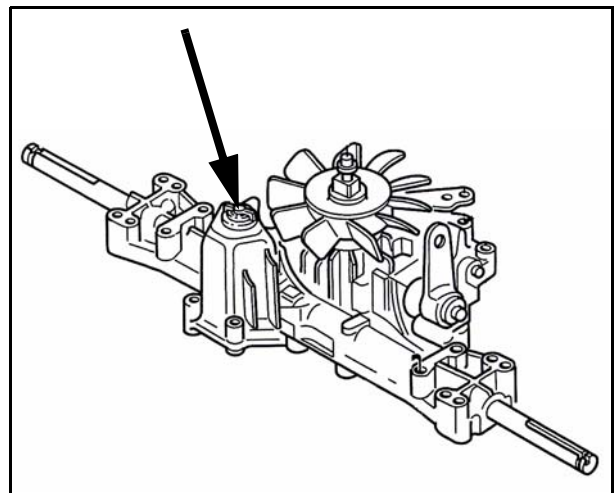

Edition	Manual	Chapter	Page
2008-05-19	Workshop Manual, Stiga Villa/Ready	5 Belts	1

## 5 Belts

### Contents in this chapter

<b>5.1 Description</b> .....	<b>2</b>	<b>5.4 Adjustments</b> .....	<b>9</b>
<b>5.2 Belt theory</b> .....	<b>3</b>	5.4.1 Adjustment of belt B .....	9
5.2.1 Why it is so important to use original belts from the retail dealer? .....	3	5.4.2 Adjustment of the clutch/brake, HST.....	10
<b>5.3 Replacement of belts</b> .....	<b>5</b>	5.4.3 Adjustment of the clutch, Man 10	
5.3.1 Disassembly of belt D .....	5		
5.3.2 Inspection and measures .....	7		
5.3.3 Assembly of belt D .....	7		

### General

All mechanical power, delivered by the motor, is conducted to the different power consumers by a belt system. The belt system has in general the same configuration in all the machines covered by this manual. Where divergences occur between the machines, particular instructions are given for each machine. The maximum tension of each belt is regulated by a spring loaded belt tensioner.

This chapter gives a brief description of the belt system and describes replacements of belts and adjustments of their tensions.

This chapter is valid for the actual machines where the actual system occur.



Edition	Manual	Chapter	Page
2008-05-19	Workshop Manual, Stiga Villa/Ready	5 Belts	2

## 5.1 Description

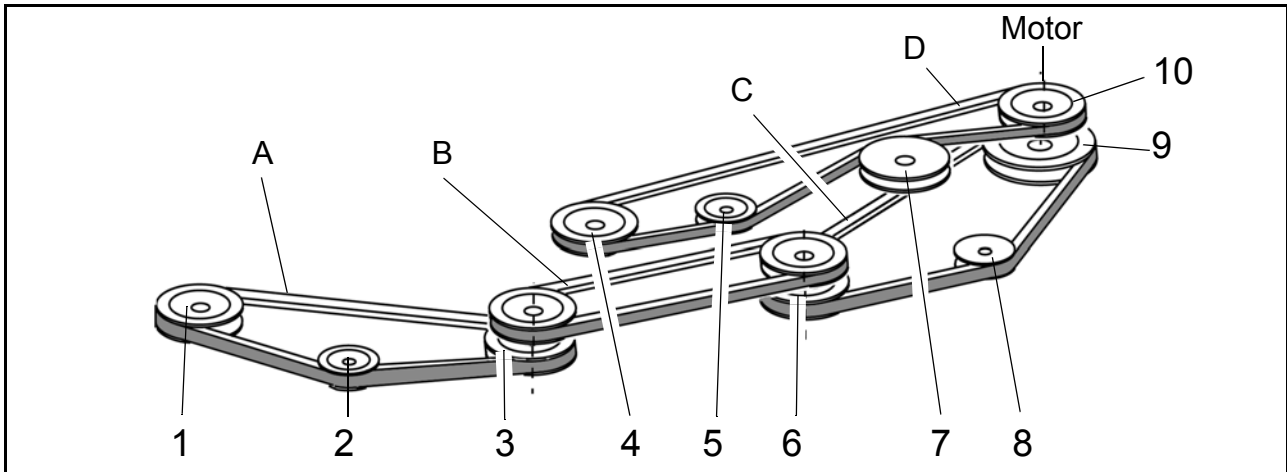

### Belt A

Belt A belongs to the work equipment and is connected to the machine at the front right pulley. The belt is tensioned by the tension pulley (2) which is mounted on a spring loaded lever.

### Belt B

Belt B is intended to deliver motor power to the front right pulley, where it can be picked up of the work equipment.

### Belt C

Belt C transmits the power to belt B and performs the mechanic PTO clutch function together with the pulley (8).

Engagement/disengagement of the mechanic PTO is performed by moving the pulley (8) to stretch/slacken the belt.

### Belt D

Belt D is intended to transmit the motor power to the transmission, where it is geared to a suitable ratio for the drive shaft. The belt is tensioned by the tension pulley (7) which together with the belt performs the clutch function.

The tensioning force is disengaged from the belt when the parking brake is activated.

### Belts:

- A. Work equipment belt (belongs to the work equipment).
- B. Work equipment belt.
- C. Work equipment clutch belt.
- D. Transmission belt.

### Pulleys:

- 1. Pulley at the work equipment.
- 2. Tension pulley.
- 3. Pulley (double).
- 4. Pulley at the transmission.
- 5. Tension pulley with the clutch function (works on the same lever as pulley 7).
- 6. Transmission pulley (double).
- 7. Tension pulley with the clutch function (works on the same lever as pulley 5).
- 8. Tension pulley (for mechanic PTO also clutch pulley for the PTO)
- 9. Drive pulley at the motor shaft.
- 10. Drive pulley at the motor shaft.

Edition	Manual	Chapter	Page
2008-05-19	Workshop Manual, Stiga Villa/Ready	5 Belts	3

## 5.2 Belt theory



### 5.2.1 Why it is so important to use original belts from the retail dealer?

The table below shows the demands on normal commercial grade belts compared to demands on original spare parts belts from the retail dealer. The later are designed and manufactured in close connection between the subcontractor and the rider manufacturer.

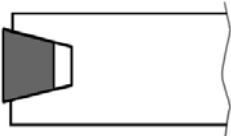
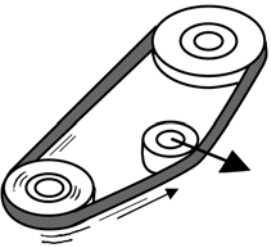
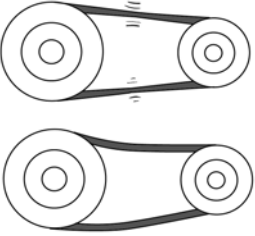
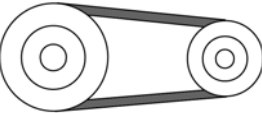
The table is intended to display the importance to use the original belts.

Case	Commercial grade belts	Original spare parts belts	Remarks
Fitness to pulleys. 	The belt shall rest with its angled sides against the pulleys. There must be a space between belt and pulley bottom.	The belt shall rest with its angled sides against the pulleys. There must be a space between belt and pulley bottom.	Same demands. Original belts guarantee that the belt fits against the pulleys.
Acceleration. 	The belt follows the motor rpm in a continuous acceleration up to full speed.	Some belts shall engage to the pulleys with the motor running in full speed, which gives an excessive generation of heat.	Common belts are made of natural rubber, which can resist temperatures up to 70° only.  Original belts are made of chloroprene rubber, which can resist temperatures up to 90°
Length	Manufactured in standard lengths in steps.. 	Manufactured in predefined lengths to fit between the pulleys.. 	The distance between the pulleys is fix. The belt tensioner gives the original belt an optimal tension.

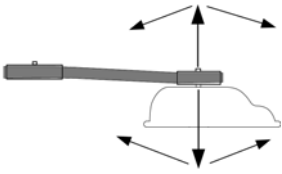
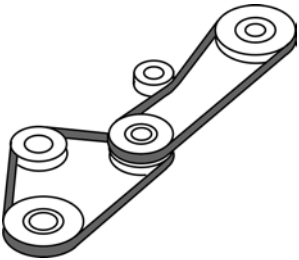
Edition	Manual	Chapter	Page
2008-05-19	Workshop Manual, Stiga Villa/Ready	5 Belts	4

Case	Commercial grade belts	Original spare parts belts	Remarks
Floating pulley at the implement. 	Designed to transmit power between aligned, parallel and fixed pulleys.	The original PTO belt is designed to operate, even if the pulleys are moving up and down and are tilting at the same time	The implement follows the ground which involves that its pulley is constant moving.  To resist the excessive operating conditions, the original belts are made of fibre reinforced rubber.
Bending in two directions 	Designed to bend around pulleys in one direction only	Most of the belts at the machine have tension rollers, actuating from the outside of the belt. This means the belt has to bend both inwards and outwards during the operation.	All original belts which operate with tension rollers actuating from the outside have reinforcements. The reinforcement is special designed for the actual case.
Noise 	Manufactured without any special respect to the actual case.	The original belts are carefully selected to give the lowest noise increment to the machine during operation.	Depending on the function of the belt, any of the following belt types are itemised: <ul style="list-style-type: none"> <li>• Wrapped</li> <li>• Non-friction</li> <li>• Raw-edge</li> </ul>

Edition	Manual	Chapter	Page
2008-05-19	Workshop Manual, Stiga Villa/Ready	5 Belts	5

## 5.3 Replacement of belts

This section describes the belt changing of belt D. For changing other belts, see actual parts of the belt D description.

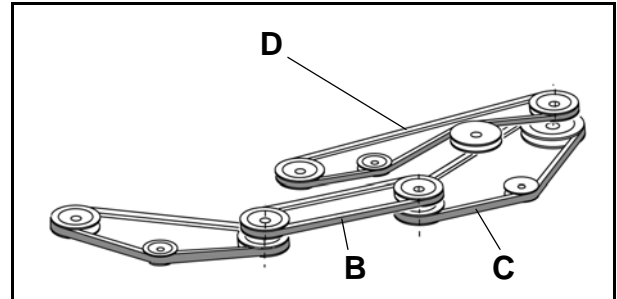

### 5.3.1 Disassembly of belt D

The belt **D** is intended to conduct the engine power to the front driving (HST or manual gearbox). The belt is controlled by a 3-armed lever for the clutch function.

Dismantle the belt as follows:

1. Raise the machine by one of the alternatives below:
  - With a highjack or similar and place 4 yokes under the shafts.
  - With a lifting table.
2. Remove the following:
  - Belt guides (X and Y)
  - Pulley (8)
  - Wire (Z) with its spring and adjuster.
3. Cut off the holding strap (E) for the wire.
4. Unscrew the two screws and nuts, holding the adjustable pulley bar (F). Remove the pulley bar with belt **C**.
5. Unhook and work off the belt **C**.

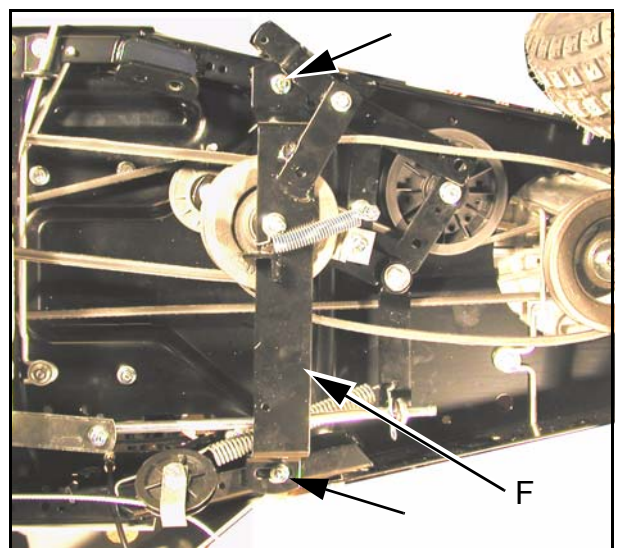
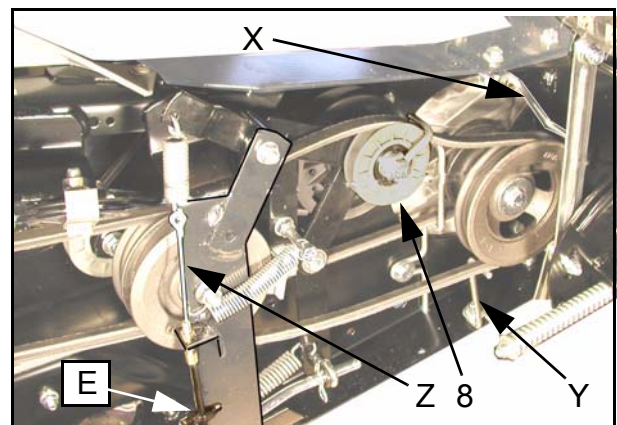



Edition	Manual	Chapter	Page
2008-05-19	Workshop Manual, Stiga Villa/Ready	5 Belts	6

6. Unhook the clutch spring.

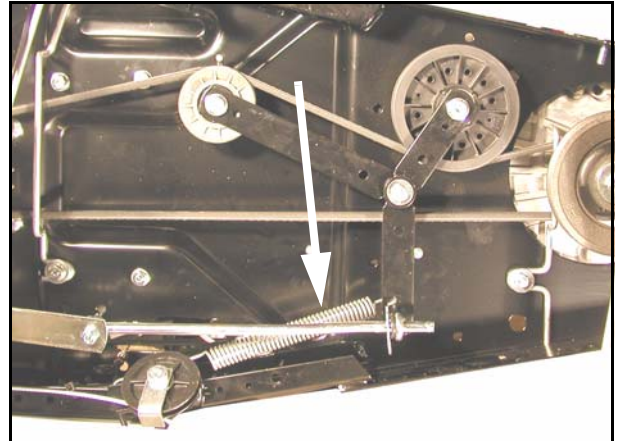

7. Remove the pulley (5). Use a 15 mm and a 17 mm wrench.

**!** Note!  
Pivot and belt guide nuts; Hold the nuts at the upper side if necessary.

8. Loosen the pivot screw (H) a couple of turns.

9. Loosen the belt guide screw (I) a couple of turns.

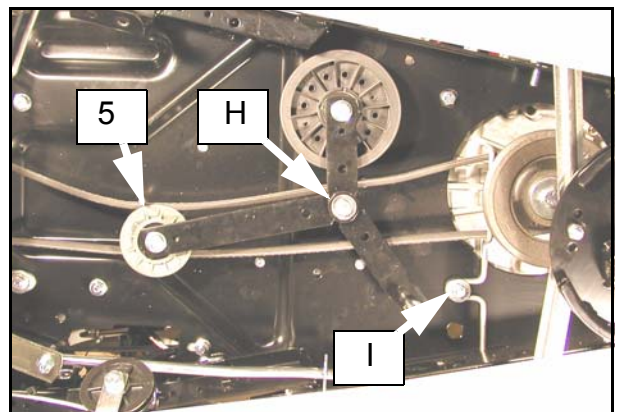

10. Remove the four front axle screws (J) and heighten the body (or lower the transmission) about 3 cm. Preferably put a 3 cm distance (K) between the axle and the body at both sides.



**Be carefully not to damage the transmission fan. A damaged fan will increase the heating and cause gearbox damages.**

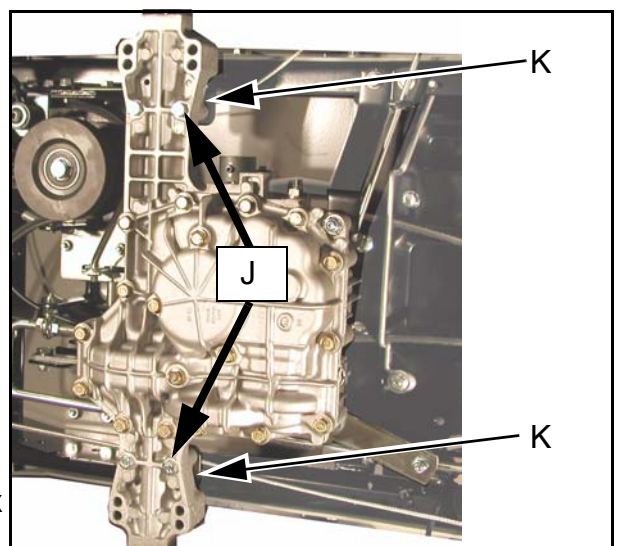

11. Work off the belt D.

Edition	Manual	Chapter	Page
2008-05-19	Workshop Manual, Stiga Villa/Ready	5 Belts	7

### 5.3.2 Inspection and measures

- Check and lubricate all links.
  - The links shall move easily and not have any major play.
  - Lubricate all pivot linkages with machine oil.
- Check the belts.
  - The belt shall rest with its angled sides against the pulleys. There must be a space between belt and pulley bottom.
  - The belt shall be intact. No loose parts or cracks.
- Check all ball bearings with respect to the following:
  - No radial play.
  - The sealing shall be intact.
  - No abnormal noise when rotating. Shall rotate evenly without stop tendency.

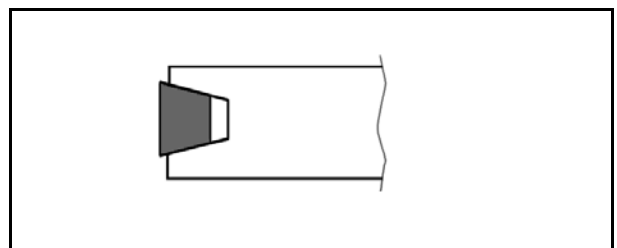
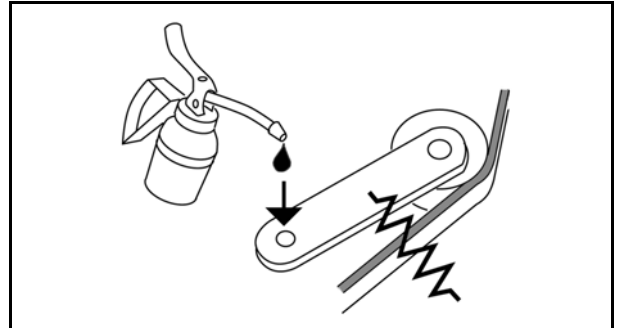

**Replace all defective parts with genuine spare parts.**

### 5.3.3 Assembly of belt D

Assemble all part in the reverse order.

Note the following at the assembly procedure:

- Be carefully not to damage the fan when fitting the belt **D** around the transmission pulley (4).
- The belt guides shall be mounted with a play of 2-3 mm to the belt when it is stretched.
- If the screws (H and I) cannot be tightened, hold the respective nut at the upper side.

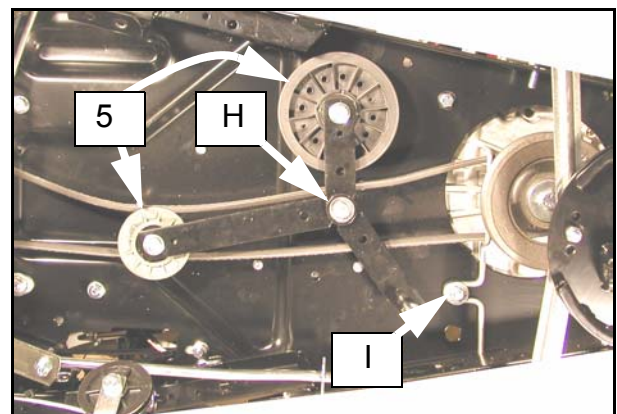

Edition	Manual	Chapter	Page
2008-05-19	Workshop Manual, Stiga Villa/Ready	5 Belts	8

4. The pulleys (5 and 7) shall be mounted with washer etc. as illustrated. The small pulley shall face with its prolonged part downwards.

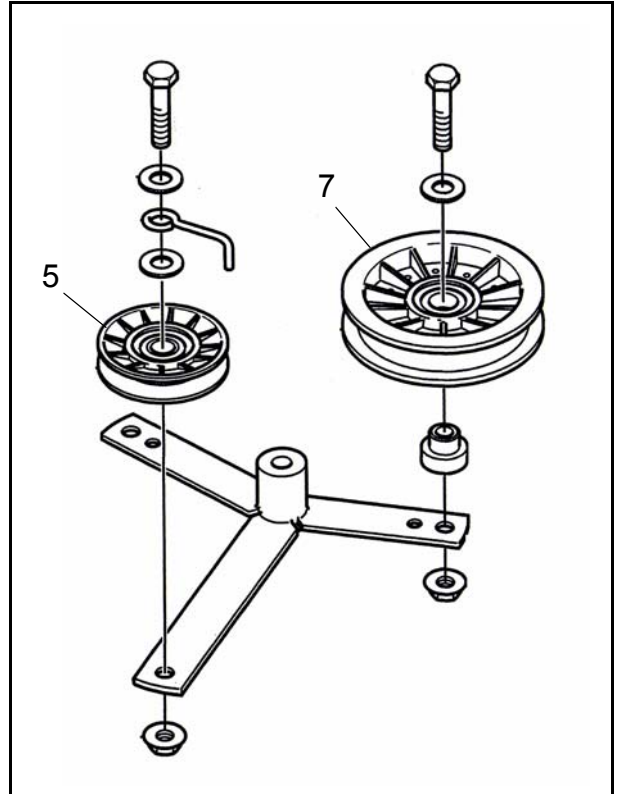

5. The belt guide at pulley (7) shall be centered over the belt when the clutch is engaged.

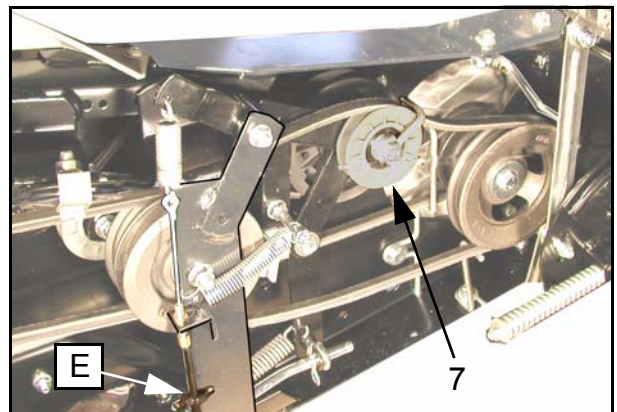

**!** Note!  
The prolonged part of the pulley hub shall face against the lever.

Edition	Manual	Chapter	Page
2008-05-19	Workshop Manual, Stiga Villa/Ready	5 Belts	9

6. Don't tighten the screws to the pulley bar (F) yet. The belt adjustment must be performed first.
7. Perform the adjustments as described below.

## 5.4 Adjustments

### 5.4.1 Adjustment of belt B

Adjust the tension of belt **B** as follows:

1. Loosen the two screws (L and M) a few turns.
2. Tension the belt by pulling the right end of the pulley bar (F) backwards by using a spring scale. Pull with a force of 85 N.
3. Tighten, simultaneously as the force is applied, the two screws (L and M).

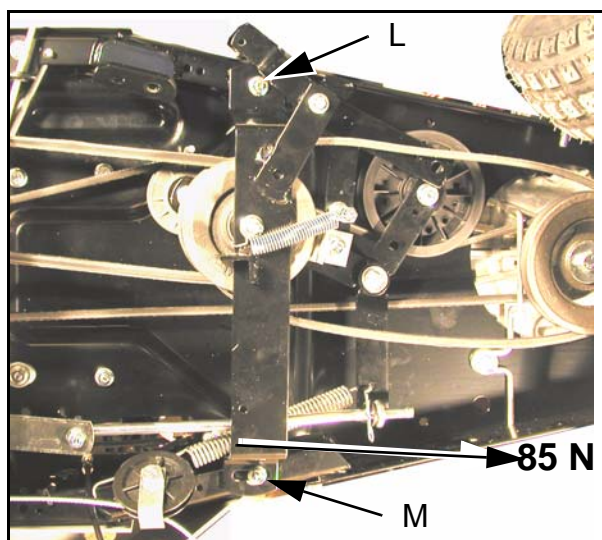
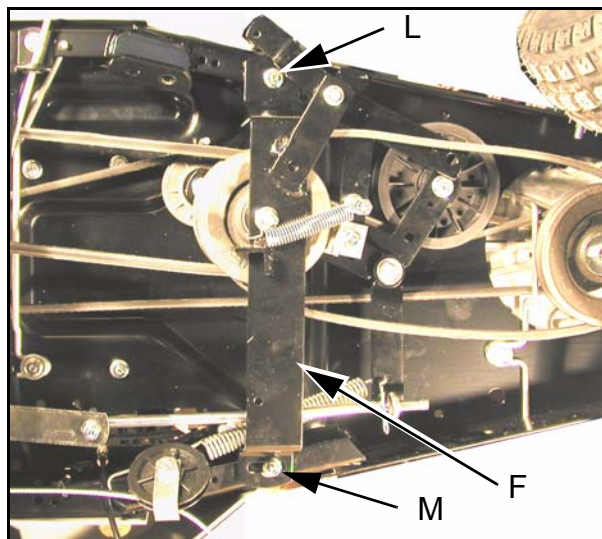

4. Fit a new fixing strap to the PTO wire.



**WARNING!**

If the fixing strap is omitted, the wire will interfere with the steering wire and be destroyed.

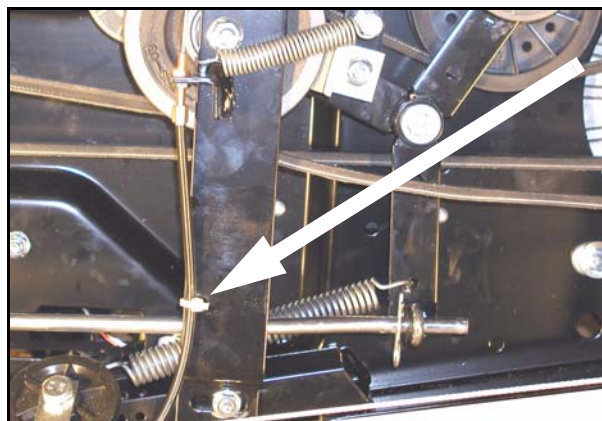

Edition	Manual	Chapter	Page
2008-05-19	Workshop Manual, Stiga Villa/Ready	5 Belts	10

### 5.4.2 Adjustment of the clutch/brake, HST

Adjust the nuts (N1 + N2) at the clutch/brake lever to a play of 3 mm between the lock pin and the clutch lever.

After the adjustment, tighten the nuts (N1 + N2).

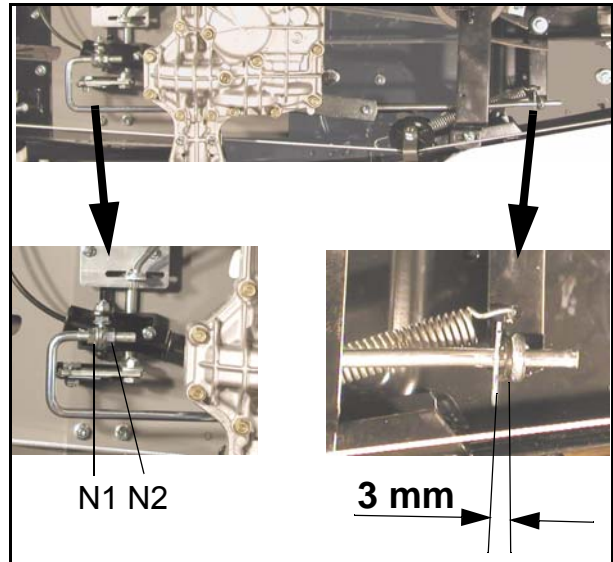

### 5.4.3 Adjustment of the clutch, Man

**!** Note!  
Manual machines shall have 0 mm play at the clutch rod (Q).

If the clutch not disengage the engine rotation properly, it will be very difficult to change gears. In that case, adjust the clutch as follows:

1. Hold the clutch rod (Q) with a polygrip and loosen the rear nut (O2) until the clutch rod (Q) is completely loose. Now, the belt stretching will perform the stop for the clutch arm (P). I.e the belt is max stretched by the spring.
2. Screw the rear nut (O2) slowly forward until the clutch arm (P) begin to move. Then screw the nut one more turn. If nessecary, move the front nut (O1) forwards.
3. Lock by screwing the forward nut (O1) backwards and tighten against the lever loop. Hold the clutch rod (Q) with a polygrip when tightening the nut.

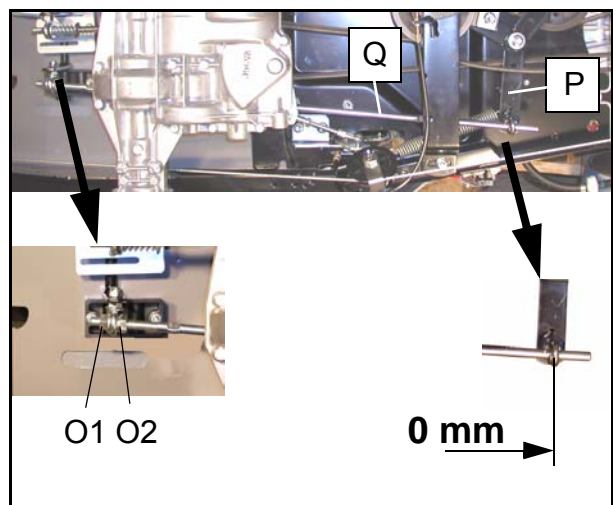

Edition	Manual	Chapter	Page
2008-05-19	Workshop Manual, Stiga Villa/Ready	6 Control wires	1

## 6 Control Wires

### Contents in this chapter

<b>6.1 Description</b> .....	<b>2</b>	<b>6.4 Throttle wire</b> .....	<b>4</b>
<b>6.2 Cable holders</b> .....	<b>2</b>	6.4.1 Dismantling .....	4
<b>6.3 PTO wire</b> .....	<b>3</b>	6.4.2 Assembly .....	4
6.3.1 Dismantling.....	3	6.4.3 Adjustment.....	4
6.3.2 Checks .....	3		
6.3.3 Assembly.....	3		
6.3.4 Adjustment .....	3		

### General

All the manoeuvring functions are collected around the operator.

All mechanical control movements from the operator to the respective device on the machine are conducted by wires or rods.

This chapter gives a brief description about the wires and information about how to replace and adjust the wires.

This chapter is valid for the actual machines where the actual system occur.



Edition	Manual	Chapter	Page
2008-05-19	Workshop Manual, Stiga Villa/Ready	6 Control wires	2

## 6.1 Description

All wires consist of a wire and a conduit. In the wire ends one part, the wire or the conduit, is fastened to the body and the other part to a lever. The levers are connected to the operator control and to the controlled device. I.e. the throttle wire, etc.

Wires can only transfer traction forces. The return forces for the wires are maintained by return springs.

To transfer higher forces and both pushing and traction forces, rods are used, i.e. brakes, etc.

### Maintenance of wires:

Drop a little engine oil or lubricating spray in the ends of the control wires two or three times a year.

## 6.2 Cable holders



### **Warning!**

**It is essential that all cable holders are fitted properly. If not, there is risk of abnormal wear, short circuit and fire.**

All wires, electrical cables and other conductors are fitted to the chassis with cable holders. Always, after removal or replacement of wires, new cable holders shall be fitted in places where they were original mounted.

Loose wires and cables cause unnecessary wear of components which finally result in electrical short circuit, paint removal and damages of plastic covers etc.

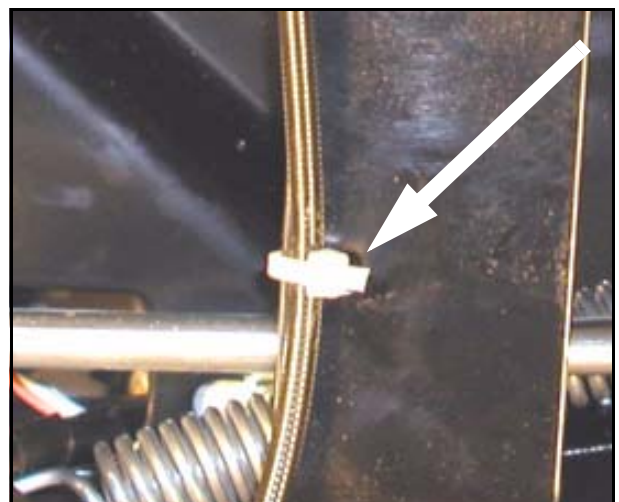

Edition	Manual	Chapter	Page
2008-05-19	Workshop Manual, Stiga Villa/Ready	6 Control wires	3

## 6.3 PTO wire

### 6.3.1 Dismantling

1. Lift the machine, either with a lifting table or by highjack and pallets.
2. Open the engine casing.
3. Unscrew the cable adjustments, upper (A) and lower (B).
4. Cut the holding strap (C) and unhook the wire.

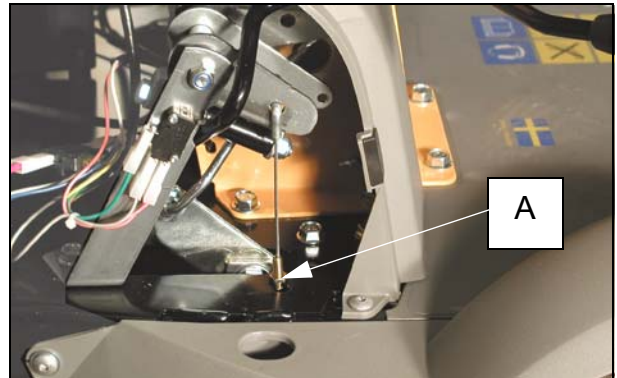

### 6.3.2 Checks

Check the brake shoe (D) for wear. If necessary replace it.

### 6.3.3 Assembly

1. Apply a couple of oil at the wire ends while moving it in its conduit.
2. Assemble in the reverse order.



#### Warning!

**If the wire is loose, it will interfere with the steering wire. It is therefore especially important that it is locked with a new holding strap correctly.**

3. Replace the holding strap (C).
4. Adjust the wire. See below.

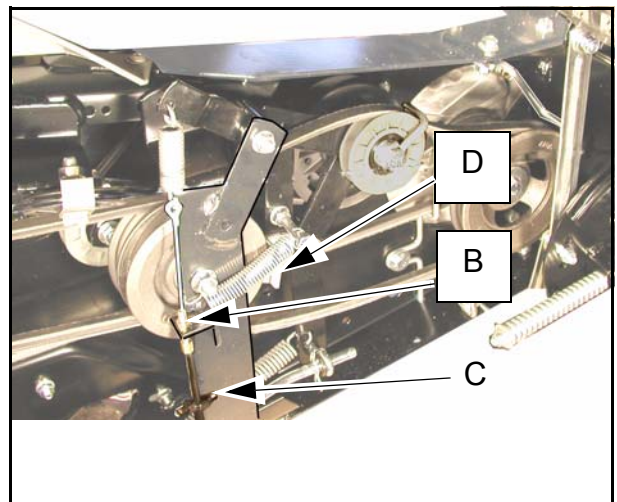

### 6.3.4 Adjustment

1. Set the cable adjustments, upper (A) and lower (B) in their middle positions.
2. Adjust about the same amount at both adjustments until the lever have a play of 3-3,5 cm.
3. Lock the adjustment nuts.





Edition	Manual	Chapter	Page
2008-05-19	Workshop Manual, Stiga Villa/Ready	6 Control wires	4

## 6.4 Throttle wire

### 6.4.1 Dismantling

1. Open the engine casing.
2. Loosen the wire conduit at the engine and at the throttle lever. At machines with the throttle lever in the front panel, remove the upper casing for access to the lever. See section 2.

**Note!**

.It is not nessecary to cut the holding strap (A).

3. Remove the wire.

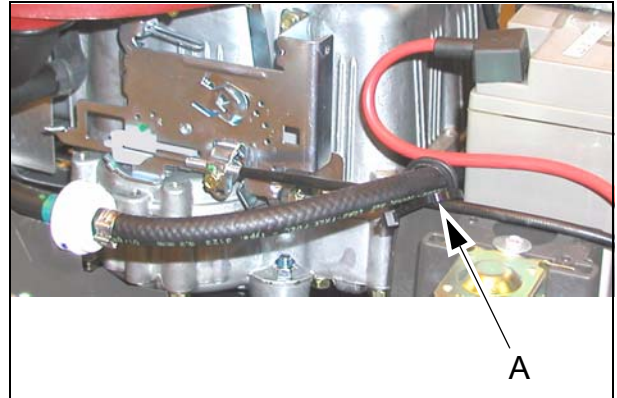

### 6.4.2 Assembly

1. Apply a couple of oil at the wire ends while moving it in its conduit.
2. Assemble in the reverse order.
3. Thread the wire through the holding strap (A) and at machines with the throttle lever in the front panel, through the holes (B).
4. Adjust the wire. See below.

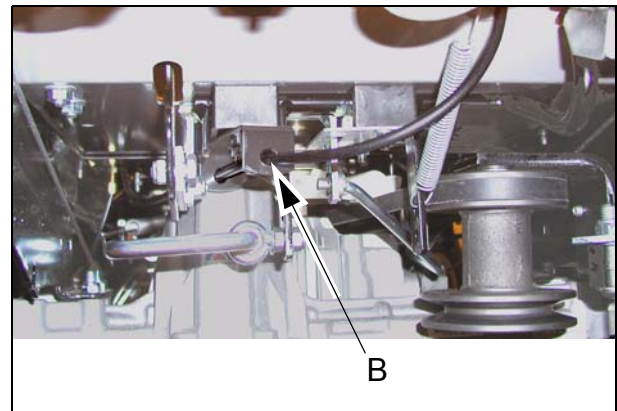

### 6.4.3 Adjustment

1. Adjust the wire conduits at the ends until the throttle lever can reach its end positions.
2. Fasten the conduit clamps.
3. Check the following:
  - Function of the choke position
  - Full throttle position

If nessecary repeat the adjustment procedure.

Edition	Manual	Chapter	Page
2008-05-19	Workshop Manual, Stiga Villa/Ready	7 Electrical System	1

## 7 Electrical System

### Contents in this chapter

7.1 Description.....	2
7.2 Trouble Shooting .....	3
7.3 Repair and replacements.....	16
7.3.1 Replacement of switches .....	16
7.3.2 Replacement of switch knob ..	16
7.3.3 Connections .....	16

### General

Each machine has its own electrical system, configured to fit the purpose and demand of the actual machine. The electrical system has two main duties, to maintain the machine safety and to make the different functions easy to handle.

The main part of this chapter consists of trouble shooting of the electrical system to isolate faults and to give information about corrective measures. The electrical system is also described. There are also given instructions about general repair and replacement procedures.



Edition	Manual	Chapter	Page
2008-05-19	Workshop Manual, Stiga Villa/Ready	7 Electrical System	2

## 7.1 Description

The electrical components are connected with cables, integrated in a complete insulated harness, which is unique for each machine model. Thus the cables are protected against wear, contaminations and other stresses. The cables are connected to the actual components with tab or screw connectors and in some cases with multi-contact connectors.

The electrical system contains several safety circuits. Therefore actual levers and pedals are provided with micro switches. The micro switches are shown in the figure below. The signals from the micro switches are used to interlock the actual circuit in case of a forbidden manoeuvre attempt. Some manual switches and relays have also built in interlocks, related to the safety system.

All current consumption circuits except the start circuit are protected by 1-3 fuses, depending on the machine model.

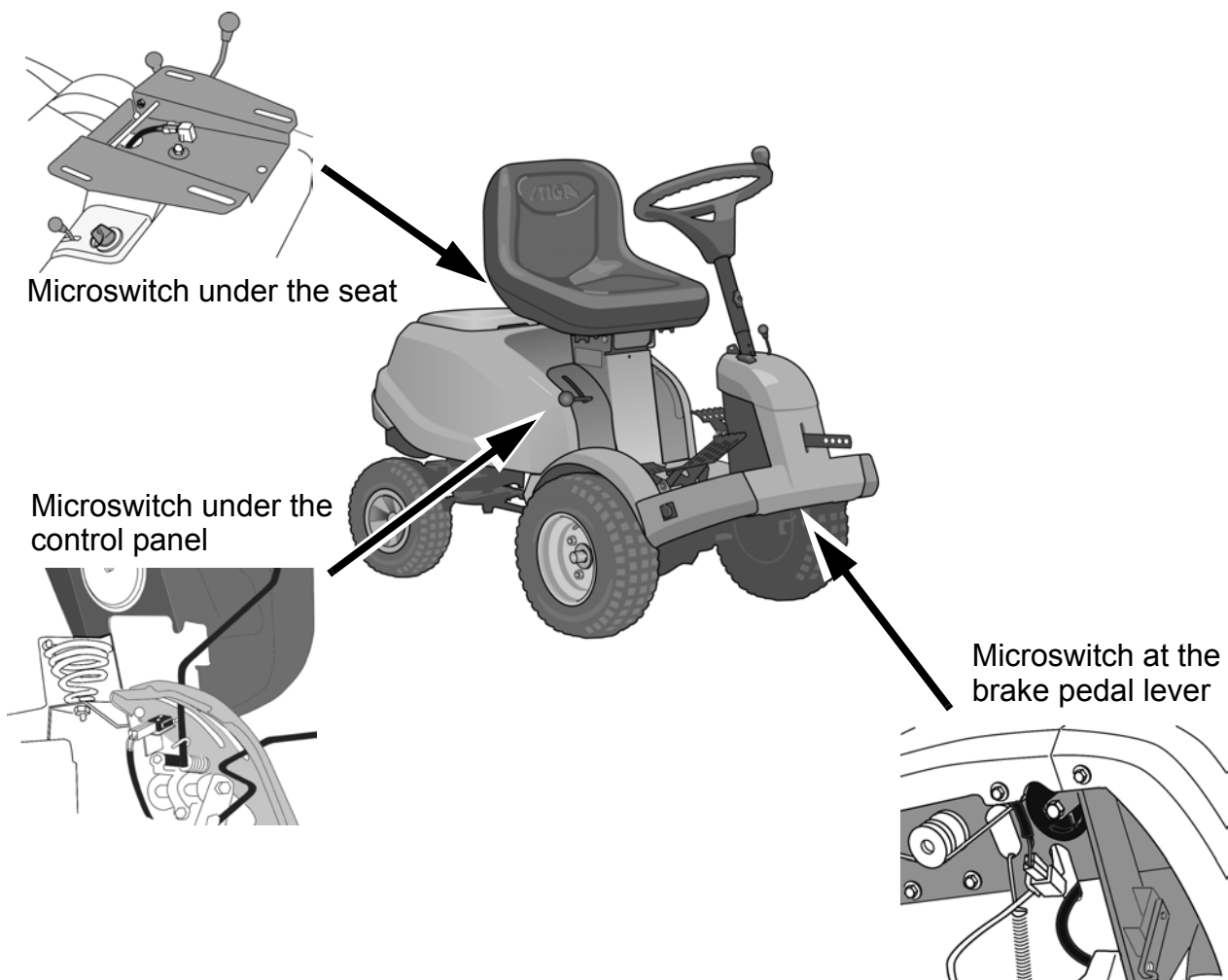

Edition	Manual	Chapter	Page
2008-05-19	Workshop Manual, Stiga Villa/Ready	7 Electrical System	3

## 7.2 Trouble Shooting



### Warning!

**Do not wear rings, metallic bracelet, chain round the neck or similar metal objects when working with the electrical system. It can cause short-circuit, burns and fire.**

This section describes the trouble shooting procedures in absence of an electrical function. It also describes the correction measures in each actual case. When following the trouble shooting schedules, it is provided that the following states are fulfilled:

- All fuses are checked and, if necessary replaced.
- The battery shall be charged.
- The requirements for the actual measure shall be fulfilled. E.g. if it is advised to perform a start attempt, the operator shall sit down on the seat, press the brake pedal and the power take off shall be in disengaged position.

When following the trouble shooting schedules, it is in normal cases assumed that conductors and connectors to conductors are OK. However, in some cases, after a long period of use or in case of mechanical damages, the cables at the articulating point can be damaged. The circuit diagrams are presented in the respective spare parts manual.

The following operation faults for models 2002-2007 are described.

Paragraph	Page
7.2.1 The starter does not rotate . . . . .	4
7.2.2 The starter rotate, but the motor does not start . . . . .	8
7.2.3 The battery runs repeatedly empty . . . . .	10
7.2.4 The motor does not stop . . . . .	11
7.2.5 Electric cutting height adjustment . . . . .	12
7.2.6 The PTO clutch does not engage . . . . .	12
7.2.7 The motor can be started without the brake pedal is pressed . .	13
7.2.8 The motor can be started with the mover deck activated . . . . .	13
7.2.9 The motor can be started with a gear activated . . . . .	13
7.2.10 The motor does not stop when the operator leaves the seat and the mover deck is activated . . . . .	14
7.2.11 The PTO clutch does not disengage when the operator leaves the seat and the mover deck is activated . . . . .	14
7.2.12 The motor does not stop after a few minutes when the shut off valve cable is disconnected . . . . .	15

Edition	Manual	Chapter	Page
2008-05-19	Workshop Manual, Stiga Villa/Ready	7 Electrical System	4

### 7.2.13 The starter does not rotate

#### Ready Man, Villa 12r

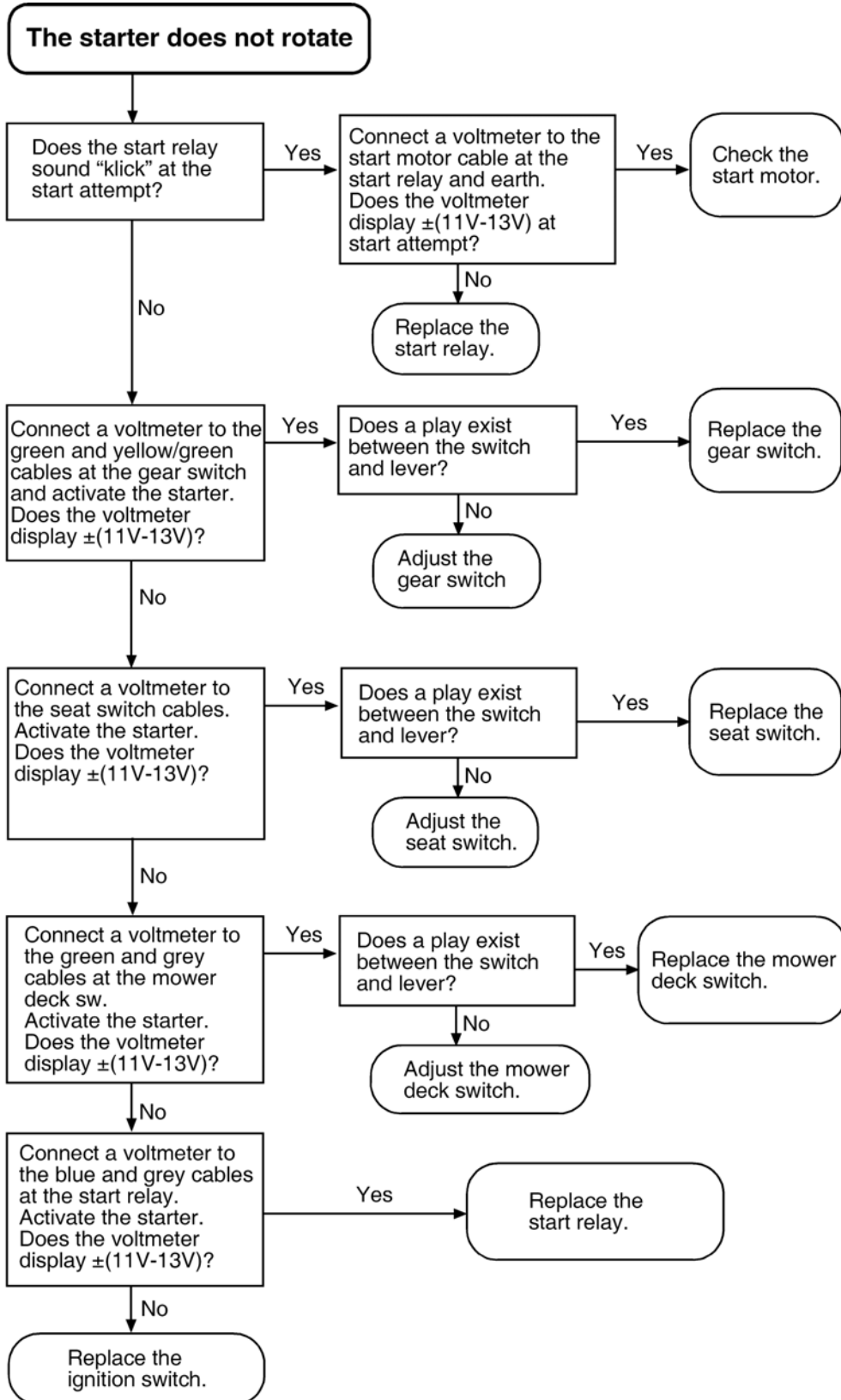

Edition	Manual	Chapter	Page
2008-05-19	Workshop Manual, Stiga Villa/Ready	7 Electrical System	5

### Villa Comfort, Villa Elit

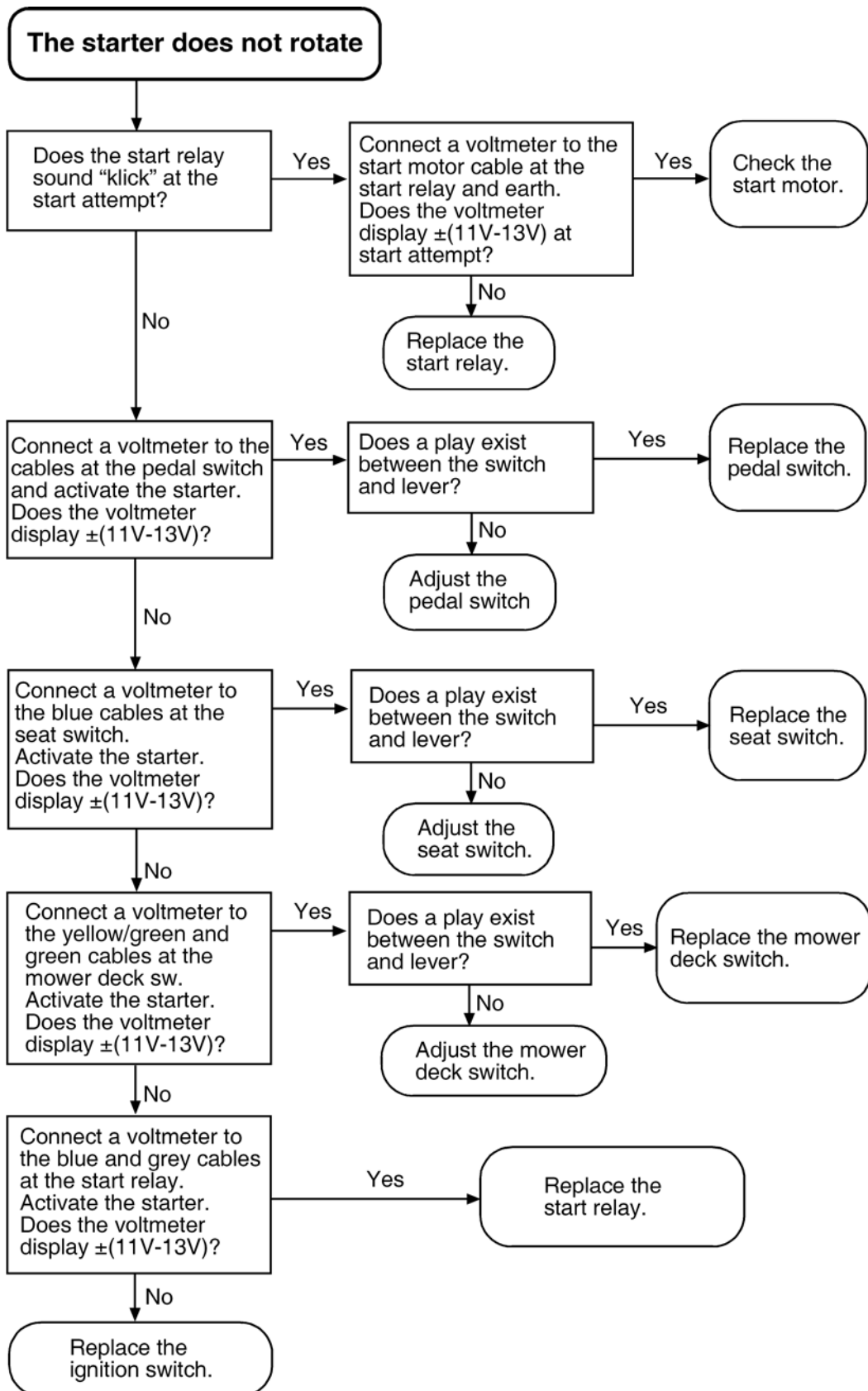

Edition	Manual	Chapter	Page
2008-05-19	Workshop Manual, Stiga Villa/Ready	7 Electrical System	6

**Ready HST, Villa 14 HST, Villa 16 HST**

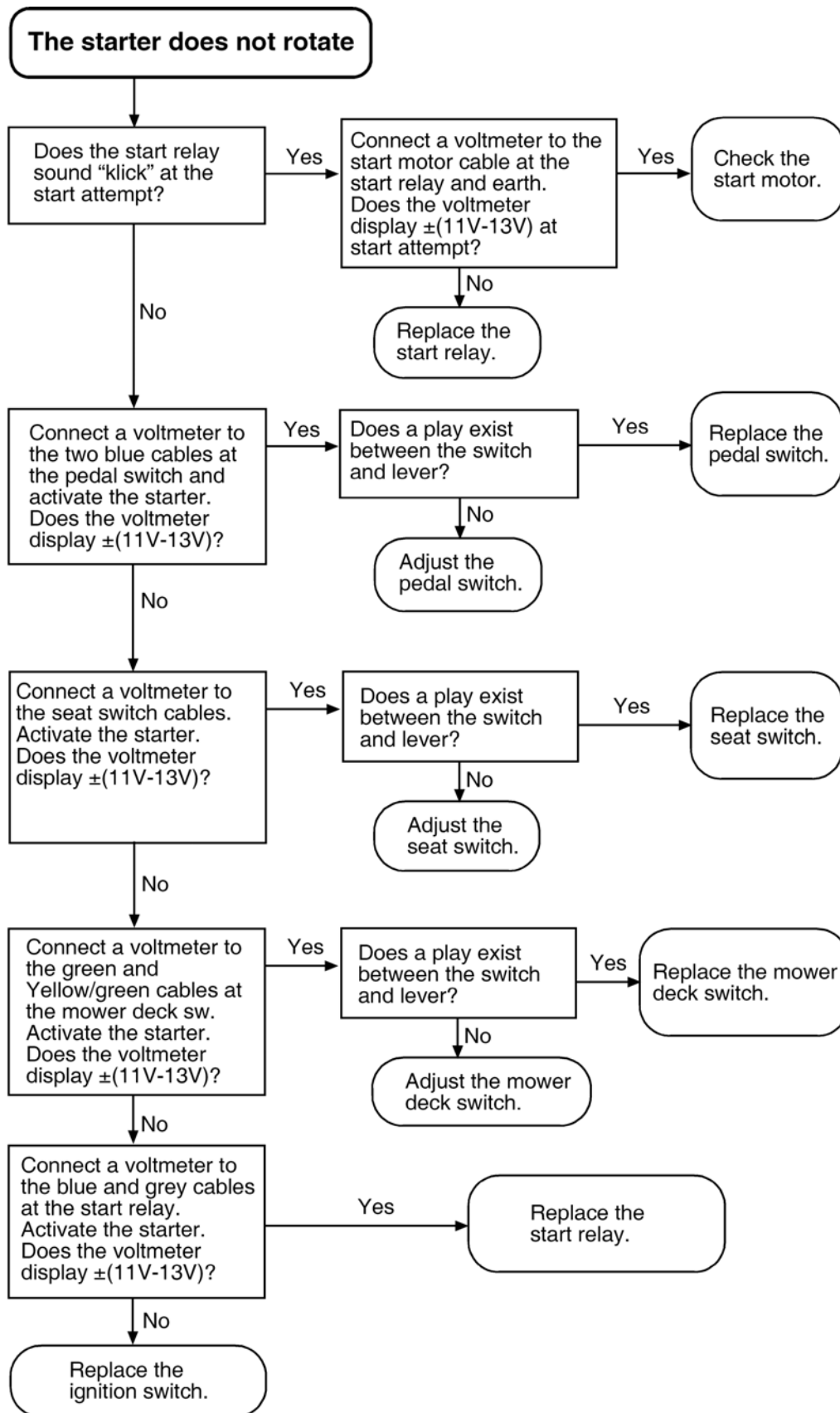

Edition	Manual	Chapter	Page
2008-05-19	Workshop Manual, Stiga Villa/Ready	7 Electrical System	7

### Villa de Lux, Villa Royal

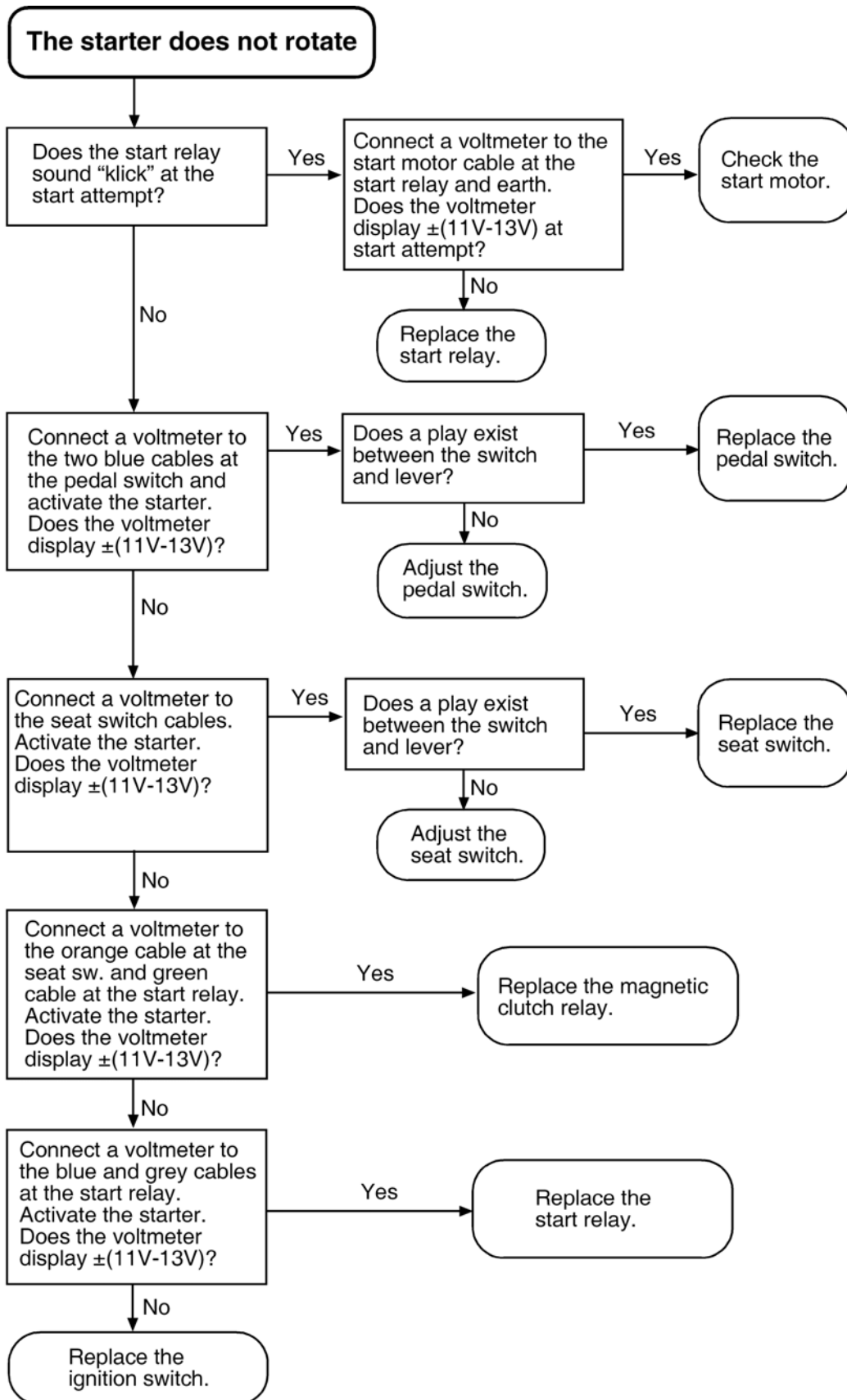



Edition	Manual	Chapter	Page
2008-05-19	Workshop Manual, Stiga Villa/Ready	7 Electrical System	8

### 7.2.14 The starter rotate, but the motor does not start

Ready Man, Villa 12, Villa Comfort, Villa Elit 14

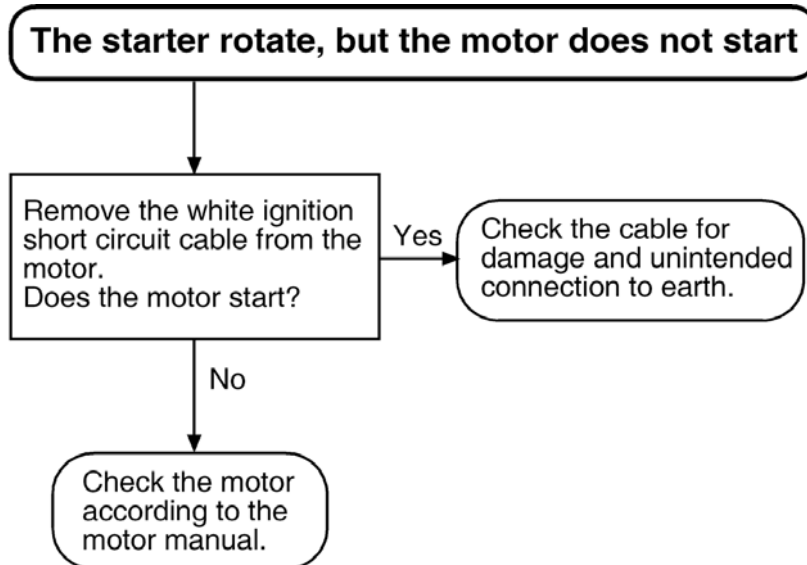

Ready HST, Villa 14 HST, Villa 16 HST

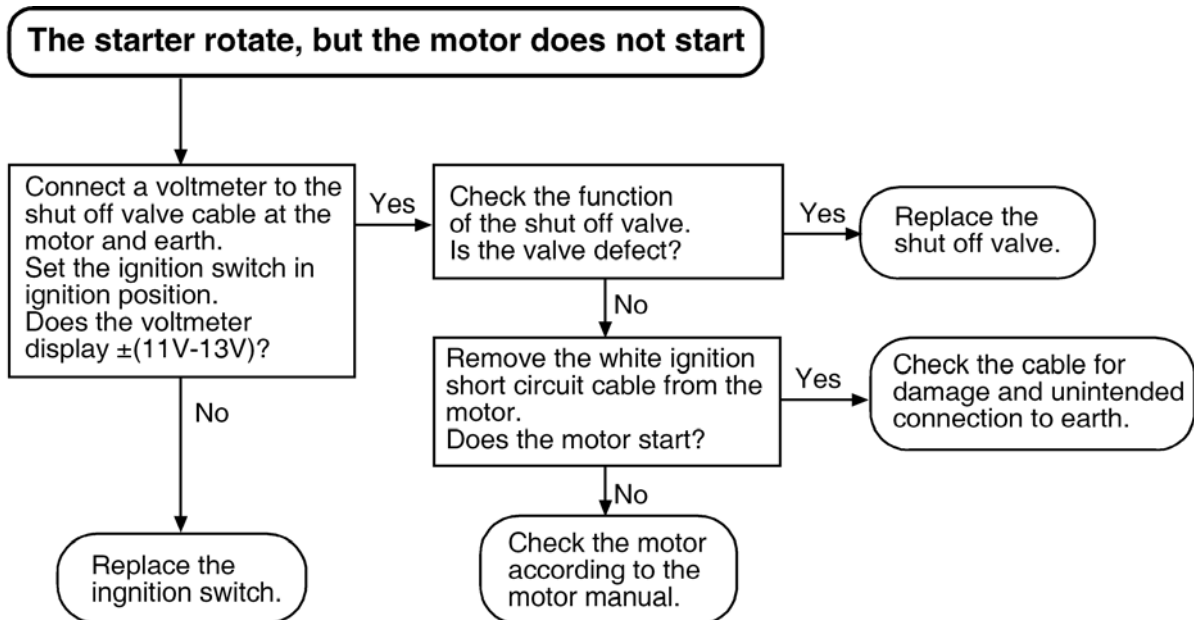

Edition	Manual	Chapter	Page
2008-05-19	Workshop Manual, Stiga Villa/Ready	7 Electrical System	9

### Villa de Lux, Villa Royal

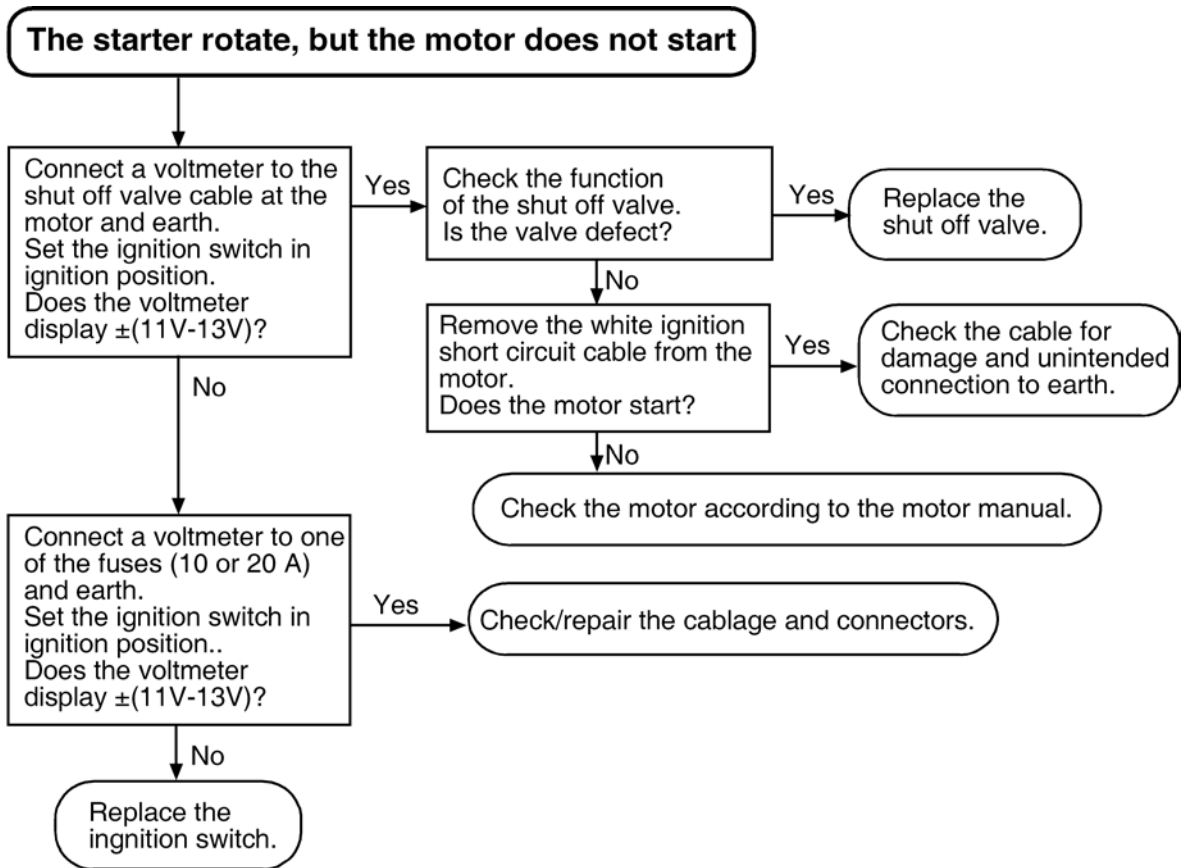

Edition	Manual	Chapter	Page
2008-05-19	Workshop Manual, Stiga Villa/Ready	7 Electrical System	10

### 7.2.15 The battery runs repeatedly empty

Ready Man, Ready HST, Villa 12, Villa 14 HST, Villa 16 HST, Villa Comfort, Villa Elit 14

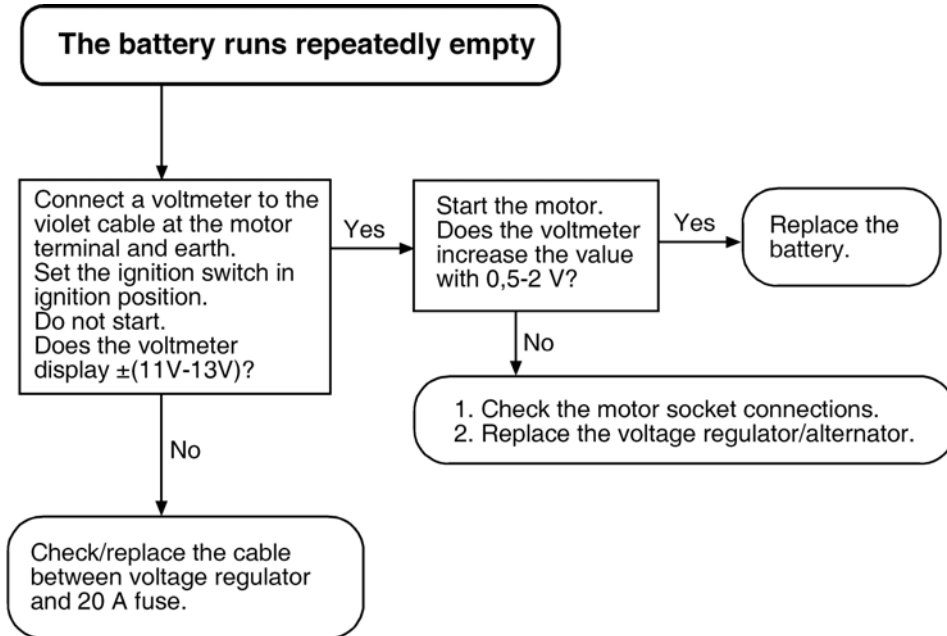

Villa de Lux

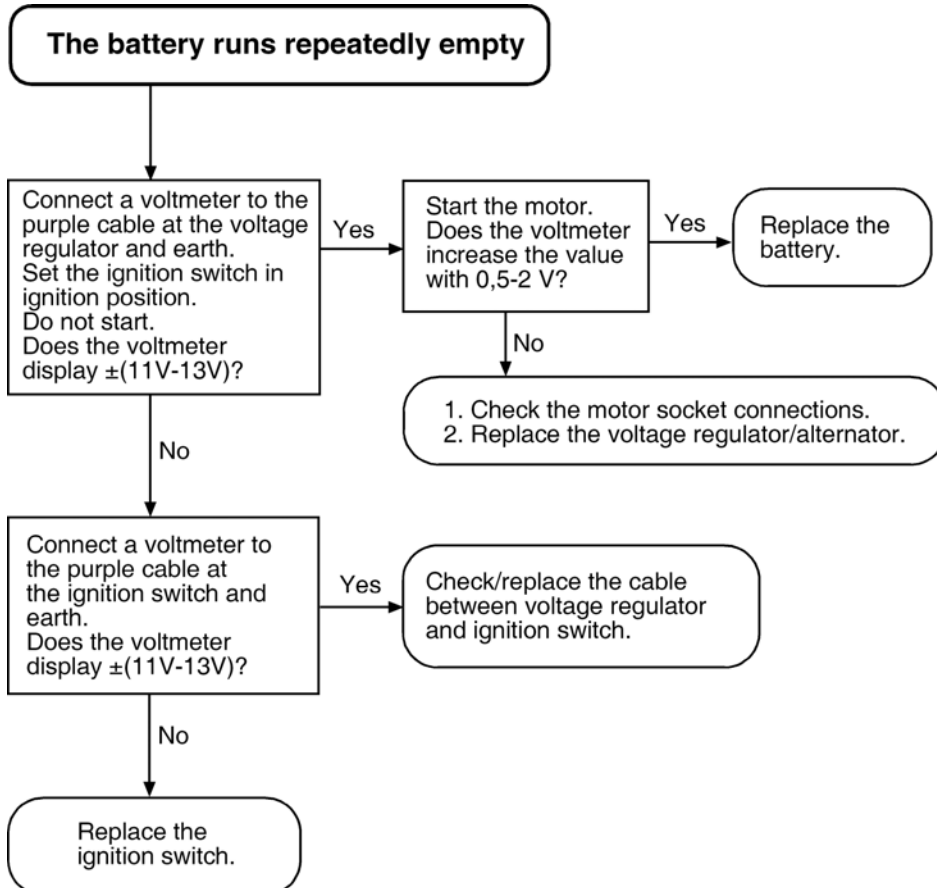

Edition	Manual	Chapter	Page
2008-05-19	Workshop Manual, Stiga Villa/Ready	7 Electrical System	11

### Villa Royal

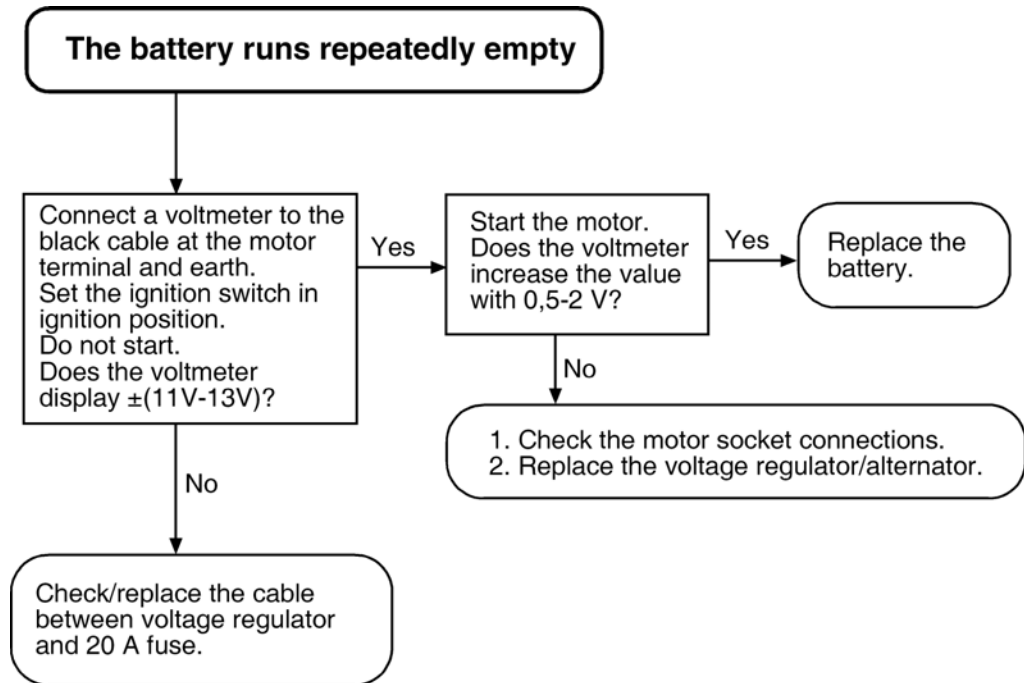

### 7.2.16 The motor does not stop

#### All machines

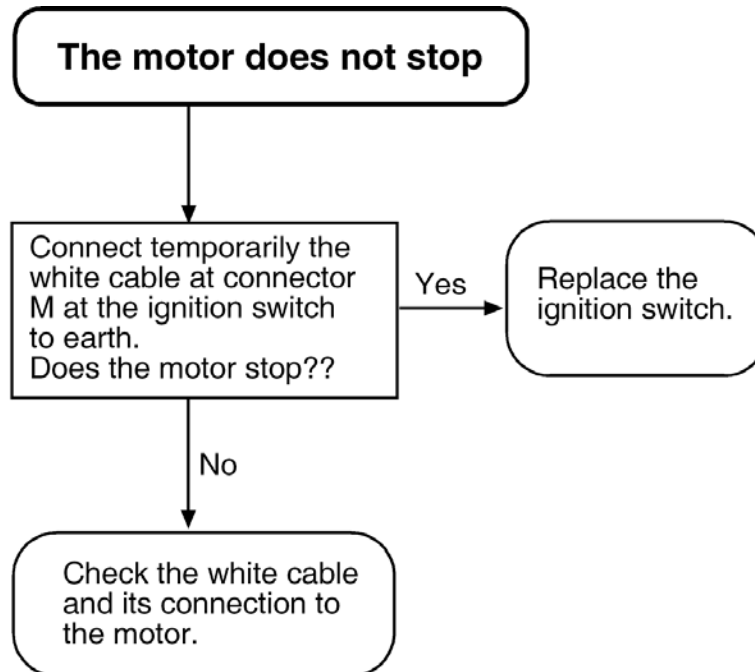

Edition	Manual	Chapter	Page
2008-05-19	Workshop Manual, Stiga Villa/Ready	7 Electrical System	12

### 7.2.17 Electric cutting height adjustment

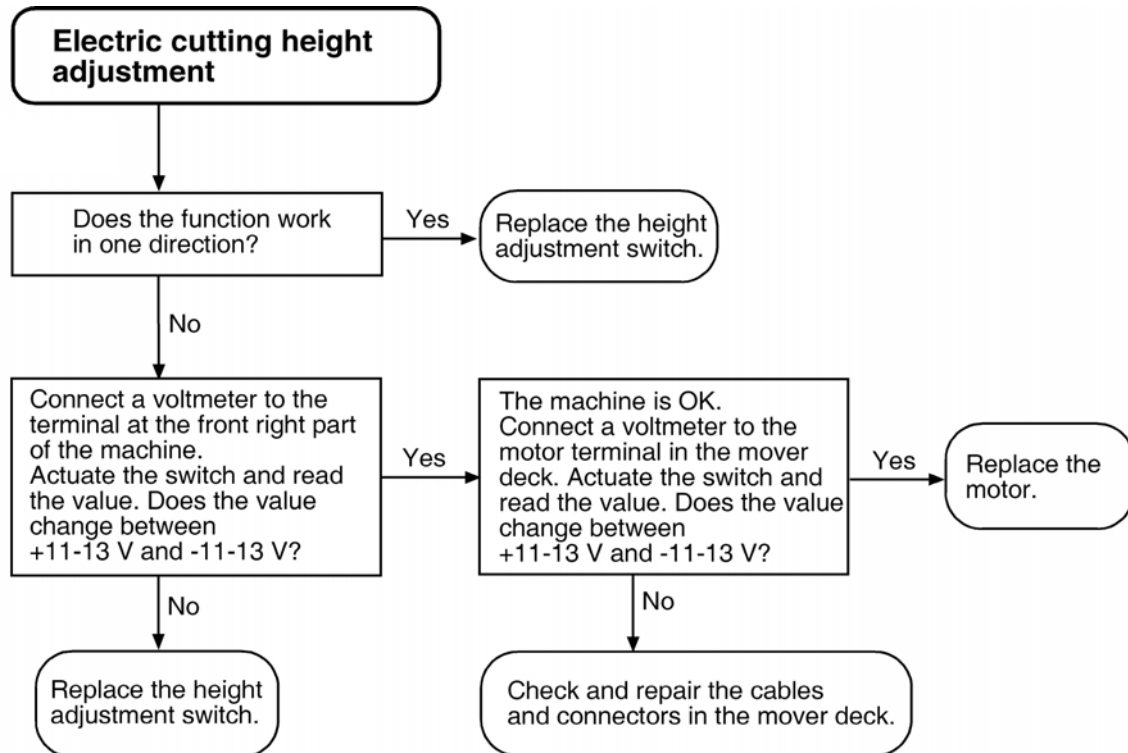

Edition	Manual	Chapter	Page
2008-05-19	Workshop Manual, Stiga Villa/Ready	7 Electrical System	13

## 7.2.18 The PTO clutch does not engage

### Villa de Lux, Villa Royal

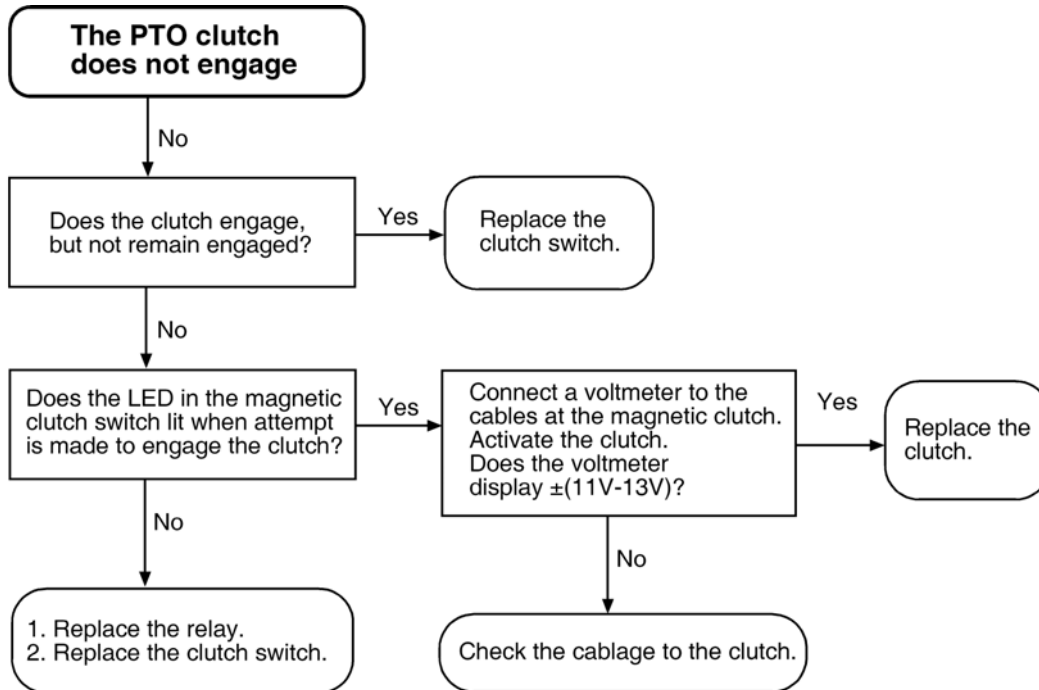

### PTO clutch characteristic

Due to high temperature and magnetic stress, the PTO clutch, after a long term of use, can show up instability in the internal components. This can result in that the clutch works properly when it is cold, but sometimes (not always) failures after warming up.

Therefore, to be sure to isolate the fault, the PTO clutch must be checked in both cold and warm condition; particular in **warm** condition.

Edition	Manual	Chapter	Page
2008-05-19	Workshop Manual, Stiga Villa/Ready	7 Electrical System	14

### 7.2.19 The motor can be started without the brake pedal is pressed

All machines except machines with manual gearboxes

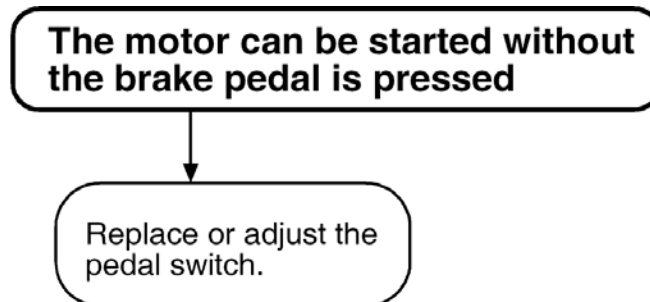

### 7.2.20 The motor can be started with the mover deck activated

All machines with mechanic PTO

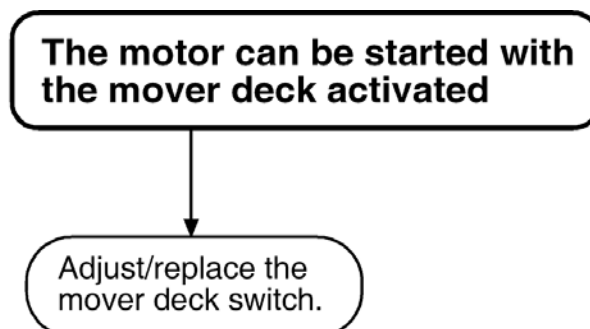

### 7.2.21 The motor can be started with a gear activated

Machines with manual gearboxes

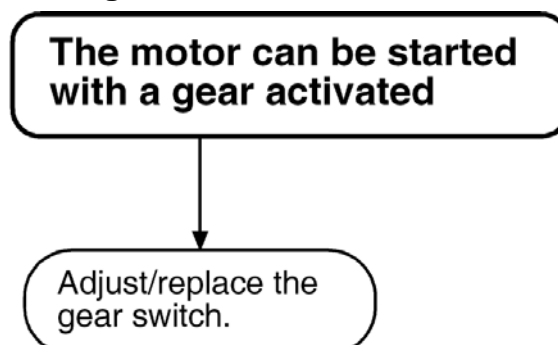

Edition	Manual	Chapter	Page
2008-05-19	Workshop Manual, Stiga Villa/Ready	7 Electrical System	15

### 7.2.22 The motor does not stop when the operator leaves the seat and the mover deck is activated

All machines with mechanic PTO

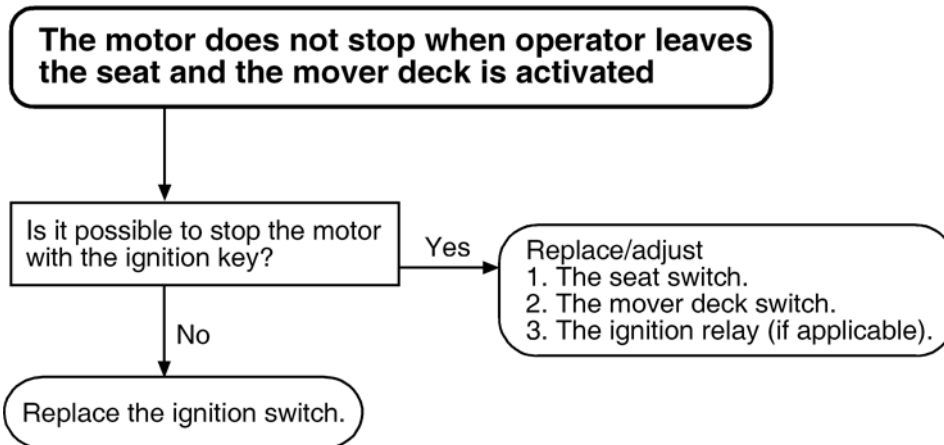

### 7.2.23 The PTO clutch does not disengage when the operator leaves the seat and the mover deck is activated

All machines with electric PTO clutch

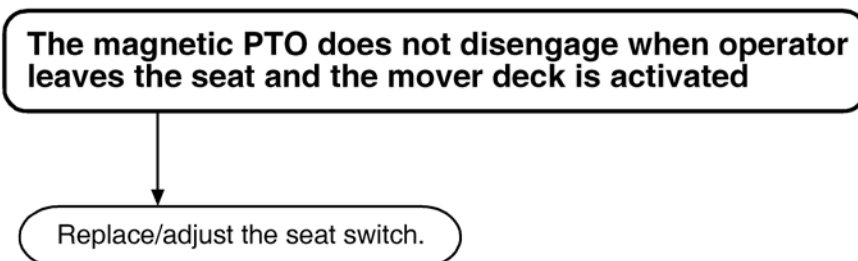

### 7.2.24 The motor does not stop after a few minutes when the shut off valve cable is disconnected

All machines with electric shut off valve in the fuel system

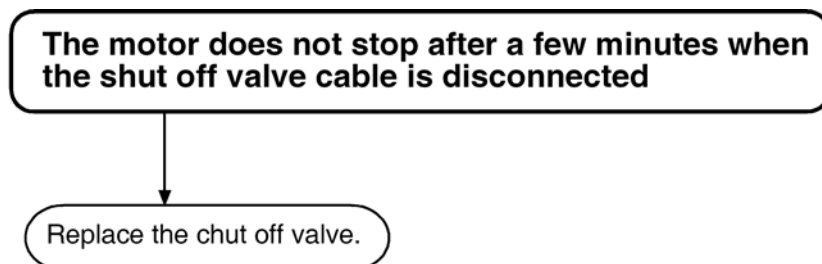



Edition	Manual	Chapter	Page
2008-05-19	Workshop Manual, Stiga Villa/Ready	7 Electrical System	16

## 7.3 Repair and replacements



### Warning

Do not wear rings, metallic bracelet, chain round the neck or similar metal objects when working with the electrical system. It can cause short-circuit, burns and fire.

### 7.3.1 Replacement of switches

All switches are pressed into place in their rectangular holes at the control panel. To change a switch proceed as follows:

1. Remove the actual cover to get access to the switch.
2. Press the fixation pig at the connector and pull the connector from the switch. See the figure. Some connectors have 2 pigs.
3. Press the fixation tongues on both sides of the switch against the switch. Use a screwdriver or similar and work up the switch. See the figure.

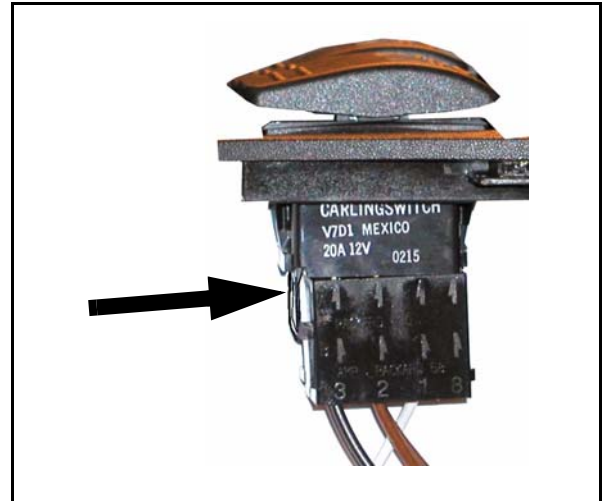

### 7.3.2 Replacement of switch knob

To replace the switch knob, there is a special tool available. Regarding reference number, see the spare parts list

Remove the knob by pushing in the tool backwards and press until the knob jumps up.

The knob is easily assembled by pressing it down in its hole in the switch.

### 7.3.3 Connections

The machine is equipped with three kinds of connectors:

- Fixed connectors in plastic holders.
- Tab connectors
- Screw connectors

All connectors shall be kept free from contamination, corrosion and damp.

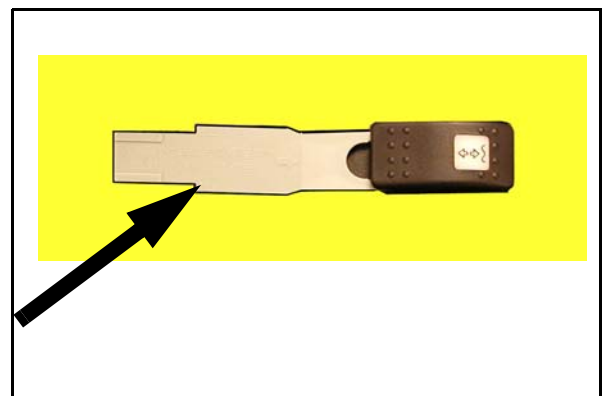

Edition	Manual	Chapter	Page
2008-05-19	Workshop Manual, Stiga Villa/Ready	7 Electrical System	17

### Fixed connectors in plastic holders

To remove the connectors from the plastic holder, put a small screwdriver behind the connector, hold the cable and pull out the connector.

See the figure.

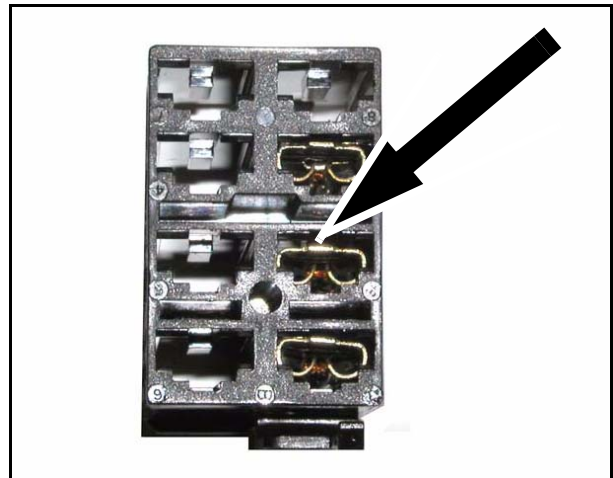

### Tab connectors

To restore tab connectors if bad crimp forces occur, e.g. after a long time of use, the connector can be pinched by a pliers.

See the figure.

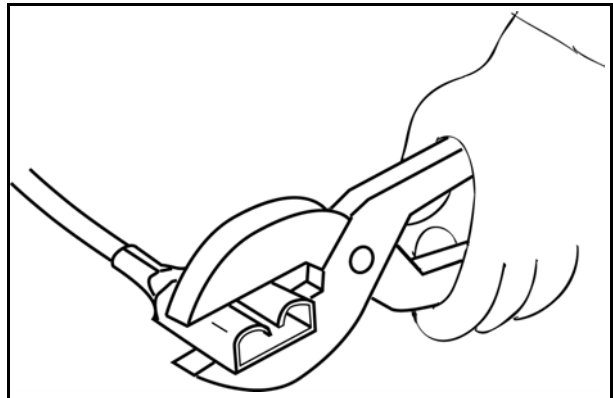

### Screw connectors

When cables shall be connected into screw connectors, the cable shall be stripped off 5 mm only. No metallic conductor is allowed to be exposed outside the terminal.



#### Warning!

Exposed conductors can cause short-circuit and fire.

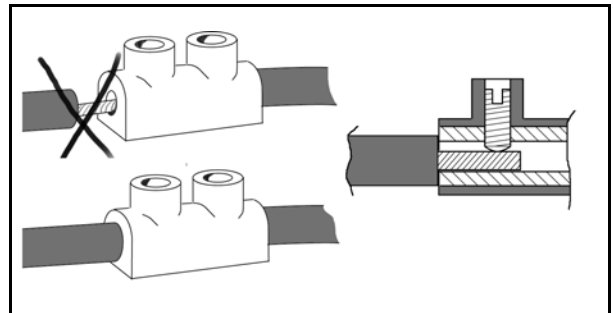

**STIGA**

STIGA S.p.A - Via del Lavoro, 6 - 31033 Castelfranco Veneto (TV) - Italien  
[www.stiga.com](http://www.stiga.com)