

ECHO®

shindaiwa®

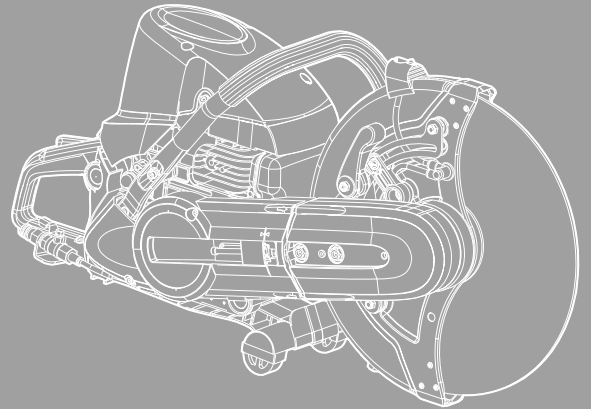

SERVICE MANUAL

ECHO: CSG-7410ES

shindaiwa:

EC741S

(Serial number: 3000001 and after)

(Serial number: 3800001 and after)

REVISED May 2021
Ref. No. 401-45

INTRODUCTION

This service manual contains information for service and maintenance of **ECHO ENGINE CUT-OFF SAW**, model **CSG-7410ES**, **shindaiwa ENGINE CUT-OFF SAW**, model **EC741S**.

For systematic diagnosis, to avoid extra work, time loss and to meet Emission regulation, please refer to “Troubleshooting guide” that describes problems, testing, remedies and references. We recommend you make use of Operator’s Manual and Parts Catalogue together with this manual when servicing.

We are constantly working on technical improvement of our products. For this reason, technical data, equipment and design are subject to change without notice. All specifications, illustrations and directions in this manual are based on the latest product information available at the time of publication.

NOTE: This service manual contains pictures with different model name for other markets and different colored model.

	Page		Page
1 SERVICE INFORMATION	2	5 CLUTCH SYSTEM AND BELT DRIVING SYSTEM	37
1-1 Specifications	2	5-1 Adjusting belt tension	37
1-2 Technical data	3	5-2 Inspecting and replacing belt.....	38
1-3 Torque limits	4	5-3 Inspecting clutch parts.....	40
1-4 Special repairing materials.....	4	5-4 Installing clutch parts.....	41
1-5 Service Limits	5		
1-6 Special tools	6	6 HANDLE AND CONTROL SYSTEM	42
2 STARTER SYSTEM	7	6-1 Replacing cushions and rear handle	43
2-1 Disassembling starter assembly.....	8	6-2 Replacing throttle system	44
2-2 Assembling starter assembly	10		
2-3 Replacing oilseal	12	7 ENGINE	45
2-4 Replacing starter pawl.....	12	7-1 Cleaning cooling air passages	46
3 IGNITION SYSTEM	13	7-2 Inspecting muffler and exhaust port	46
3-1 Troubleshooting guide.....	14	7-3 Testing cylinder compression	47
3-2 Testing spark	15	7-4 Testing crankcase and cylinder seal.....	48
3-3 Inspecting spark plug	15	7-5 Inspecting decompressor	49
3-4 Replacing spark plug cap and coil.....	16	7-6 Inspecting cylinder and intake parts	50
3-5 Inspecting and replacing ignition switch.....	16	7-7 Inspecting piston and piston ring.....	51
3-6 Inspecting ignition coil and switch lead	17	7-8 Disassembling crankcase.....	52
3-7 Replacing ignition coil.....	18	7-9 Assembling crankcase	53
3-8 Setting pole shoe air gaps.....	18	7-10 Installing piston and cylinder	57
3-9 Inspecting and replacing magneto rotor and key	19	8 CUTTING SYSTEM	59
4 FUEL SYSTEM	21	8-1 Disassembling cutter cover assembly.....	60
4-1 Replacing air filter.....	22	8-2 Replacing pulley, drive shaft and ball bearing	61
4-2 Inspecting fuel cap and fuel strainer.....	23	8-3 Assembling cutter cover assembly	63
4-3 Inspecting fuel tank and line.....	24	9 MAINTENANCE GUIDE	65
4-4 Testing carburetor.....	25	9-1 Disassembly Chart	65
4-5 Removing carburetor, fuel line and tank vent.	26	9-2 Troubleshooting guide	66
4-6 Inspecting tank vent	27	9-3 Service Intervals.....	68
4-7 Replacing purge bulb	28		
4-8 Inspecting crankcase pulse passage	28		
4-9 Inspecting metering chamber and inlet needle valve	29		
4-10 Inspecting metering lever height	30		
4-11 Inspecting pump diaphragm and inlet screen	31		
4-12 Replacing welch plug	31		
4-13 Installing carburetor, fuel line and tank vent...	32		
4-14 Adjusting carburetor	35		
4-14-1 General adjustment rules	35		
4-14-2 Initial setting Throttle adjust screw, L mixture needle and H mixture needle	35		
4-14-3 Adjusting carburetor	36		

1 SERVICE INFORMATION

1-1 Specifications

Dimensions*	Length	mm(in)	620 (24.4)
	Width	mm(in)	240 (9.4)
	Height	mm(in)	407 (16.0)
Dry weight*		kg(lb)	10.7 (23.6)
Engine	Type	YAMABIKO, air-cooled, two-stroke, single cylinder	
	Rotation	Clockwise viewed from the output end	
	Displacement	cm ³ (in ³)	73.5 (4.485)
	Bore	mm(in)	51.0 (2.008)
	Stroke	mm(in)	36.0 (1.417)
	Compression ratio	6.92	
Carburetor	Type	Diaphragm horizontal-draft, Inner vent type	
	Model	Walbro HAD-344	
	Venturi size-Throttle bore	mm(in)	16.66 - 19.03 (0.656 - 0.749)
Ignition	Type	CDI (Capacitor discharge ignition) system Digital Magneto with stop holding function	
	Spark plug	NGK BPMR7A	
Exhaust	Muffler type	Spark arrester muffler	
Starter	Type	ES (Effortless-Start) / S (Soft-start)	
	Rope diameter x length	mm(in)	3.8 x 900 (0.15 x 35.4)
Fuel	Type**	Mixed two-stroke fuel	
	Mixture ratio	50 : 1 (2%)	
	Gasoline	Minimum 89 octane	
	Two-stroke air cooled engine oil	ISO-L-EGD (ISO/CD13738), JASO FC/FD	
	Tank capacity	L (UK.fl.oz.)	0.7 (23.7)
Clutch	Type	Centrifugal, 3 shoe slide with 3-tension spring	
Cutter	Size	mm (in)	350 (14)
	Arbor	mm	20
Pulley	Blade speed reducing ratio	2.57	
	Belt	6PJ-808	
Air filter structure	Main filter: Honeycomb type		
	Sub filter: Nonwoven fabric screen		

* Without blade

** Premixed alkylate fuel for 2-stroke can be used.

1-2 Technical data

Engine				
Compression pressure	MPa (kgf/cm ²) (psi)		0.99 (10.1) (143)	
Clutch engagement speed	r/min		3,800	
Ignition system				
Spark plug gap	mm(in)		0.6 - 0.7 (0.024 - 0.028)	
Spark test				
Tester gap w/ spark plug	mm(in)		4.0 (0.16)	
Tester gap w/o spark plug	mm(in)		6.0 (0.24)	
Secondary coil resistance	kΩ		1.5 - 2.5	
Pole shoe air gaps	mm(in)		0.3 - 0.4 (0.012 - 0.016)	
Ignition timing	at 2,700 r/min	°BTDC	18	
	at 9,000 r/min	°BTDC	30	
Carburetor				
Test Pressure, minimum	MPa (kgf/cm ²) (psi)		0.05 (0.5) (7.0)	
Metering lever height	mm(in)		Flush with diaphragm seat	
Tool to adjust mixture needles			D-shaped tool (L) P/N X645-000031	
Carburetor adjustment				
Fuel type			Mixed two-stroke fuel	Premixed alkylate fuel
Preparation			Remove cutter.	
1) Initial setting	H mixture needle	turn out	3 1/2	3 3/8
	L mixture needle	turn out	2	
	Throttle adjust screw	turn out* ¹	2 1/2	
Engine warm-up	Idle - WOT : Total	sec.	10 - 5 : 120	
2) Find idle maximum speed			Adjust L mixture needle to maximum idle speed* ²	
3) Set idle maximum speed w/ TAS		r/min	3,700	3,750
4) Set idle speed by turning Lmixture needle CCW			When carburetor or diaphragm is brand-new	When carburetor or diaphragm is brand-new
		r/min	2,800	2,800
		r/min	3,300	2,800
5) Verify final engine speed with standard equipment		r/min	Idle: 3,100 - 3,400	Idle: 2,600 - 3,000
6) Verify clutch engagement speed			Confirm clutch engagement speed. If it is less than 1.25 times the idle speed, adjust the idle speed by turning TAS CCW.	

BTDC: Before top dead center. **WOT:** Wide open throttle **CCW:** Counterclockwise **TAS:** Throttle adjust screw

*¹ Turn TAS clockwise until its head touches boss. Then turn TAS counterclockwise.

*² If clutch engages during adjustment process 2), decrease engine speed by turning TAS CCW until clutch disengages and then redo 2).

1-3 Torque limits

Descriptions		Size	kgf•cm	N•m	in•lbf	
Starter system	Starter pawl	M6	90 - 120	9 - 12	80 - 105	
	Starter case	M5**	30 - 45	3 - 4.5	26 - 40	
Ignition system	Magneto rotor (Flywheel)	M8	230 - 240	23 - 24	200 - 210	
	Ignition coil	M5**	50 - 70	5 - 7	45 - 60	
	Spark plug	M14	170 - 190	17 - 19	150 - 165	
Fuel system	Carburetor, Carburetor elbow	M5	30 - 45	3 - 4.5	26 - 40	
	Carburetor elbow	M5**	30 - 45	3 - 4.5	26 - 40	
Clutch	Clutch assembly	LM8	280 - 300	28 - 30	245 - 262	
	Clutch drum	LM8	150 - 170	15 - 17	130 - 150	
Engine	Crankcase	M5**	50 - 70	5 - 7	45 - 60	
	Cylinder	M6**	90 - 120	9 - 12	80 - 105	
	Intake insulator	M5**	30 - 45	3 - 4.5	26 - 40	
	Decompression valve	M10	120 - 150	12 - 15	105 - 130	
	Muffler	M6	150 - 170	15 - 17	130 - 150	
Others	Cylinder cover	M5**	30 - 60	3 - 6	26 - 52	
	Rear handle	Rear handle side	M5	40 - 60	4 - 6	35 - 52
		Crankcase side	M5	30 - 50	3 - 5	26 - 45
	Front handle		M6	50 - 70	5 - 7	45 - 60
			M5**	50 - 70	5 - 7	45 - 60
	Cutter arm cover	Clutch side	M5**	25 - 35	2.5 - 3.5	18 - 30
		Pulley side	M8	230 - 270	23 - 27	200 - 235
	Cutter cover plate	M5**	50 - 70	5 - 7	45 - 60	
	Pulley	M10*	200 - 230	20 - 23	175 - 200	
	Cutter guard stopper	M6	70 - 90	7 - 9	60 - 80	
Regular bolt, nut and screw		M3	6 - 10	0.6 - 1	5 - 9	
		M4	15 - 25	1.5 - 2.5	13 - 22	
		M5	25 - 45	2.5 - 4.5	22 - 40	
		M6	45 - 75	4.5 - 7.5	40 - 65	

LM: Left-hand thread

* Apply thread locking sealant (See blow).

** Precoat bolt: If the coat is peeled off, replace new one or apply ThreeBond #1344 or equivalent.
If old thread locking sealant is left in threads, correct torque may not be secured.
In case old thread locking sealant is left, remove it.

1-4 Special repairing materials





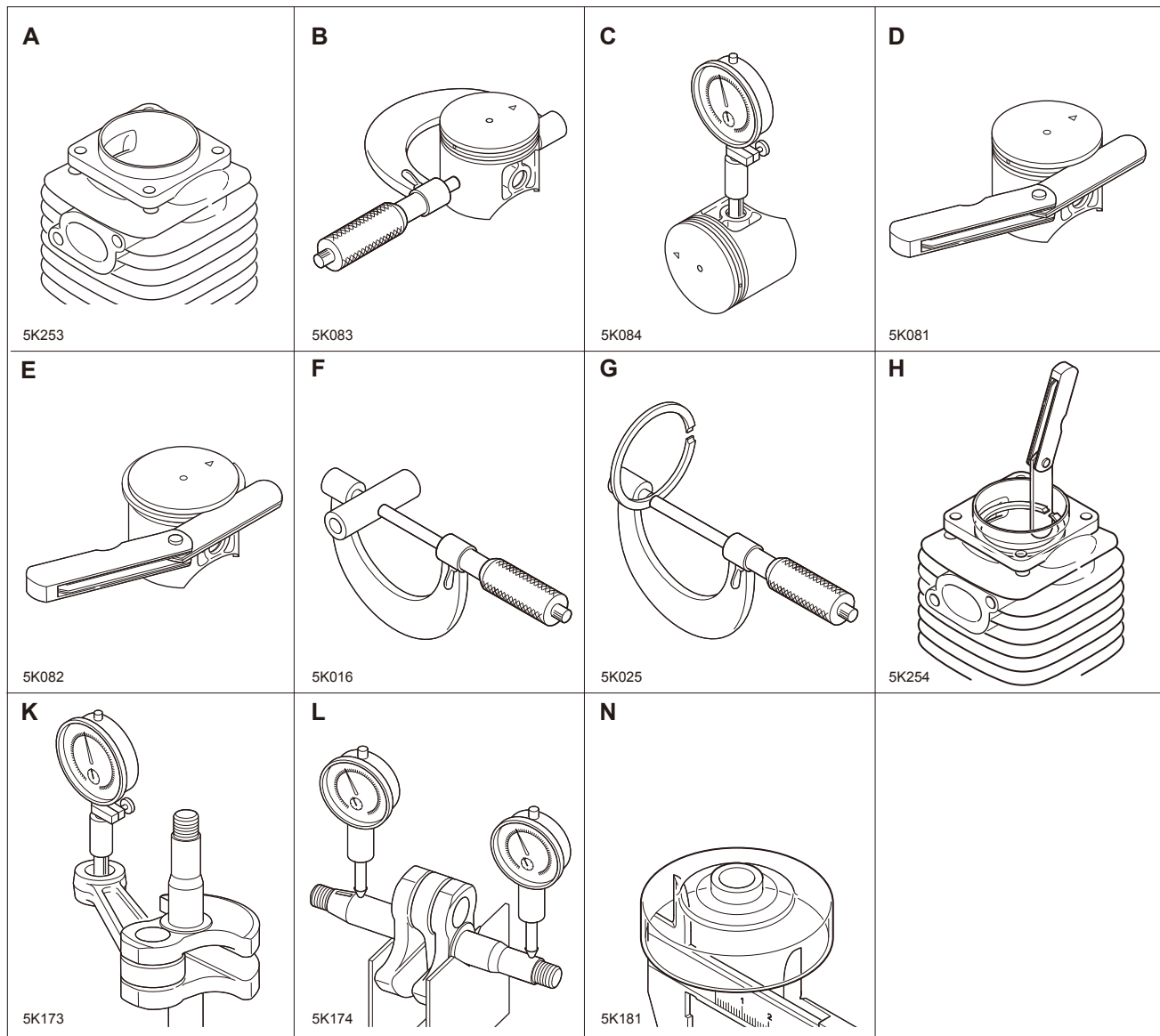





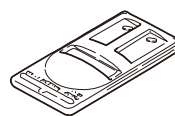
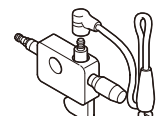

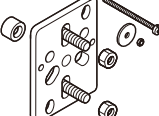
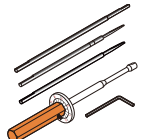
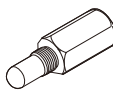
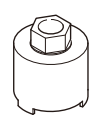

Material	Location	Remarks
Lubricant	Starter pawl	ThreeBond #1816B or equivalent
Thread locking sealant	Pulley	ThreeBond #1377B or equivalent
	Cutter cover nut	
	Starter center nut	Loctite #263 or equivalent
Grease	Starter center shaft	EPNOC AP2 (Lithium based grease) P/N X695-000060
	Main air filter groove	
	Handle cushion inside	
	Oil seal inner lips	

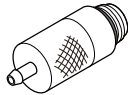
1-5 Service limits

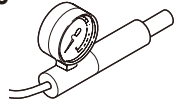

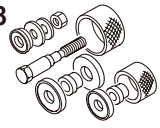
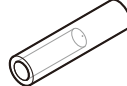
Description			mm (in)
A	Cylinder bore		When plating is worn and aluminum can be seen
B	Piston outer diameter	Min.	50.89 (2.004)
C	Piston pin bore	Max.	12.030 (0.4736)
D	Piston ring groove	Max.	1.6 (0.063)
E	Piston ring side clearance	Max.	0.15 (0.006)
F	Piston pin outer diameter	Min.	11.98 (0.4717)
G	Piston ring width	Min.	1.45 (0.057)
H	Piston ring end gap	Max.	0.6 (0.02)
K	Con-rod small end bore	Max.	15.025 (0.5915)
L	Crankshaft runout	Max.	0.03 (0.0012)
N	Clutch drum bore	Max.	79.5 (3.13)

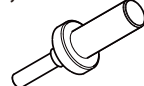
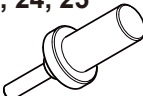
1-6 Special tools

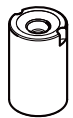
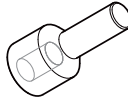
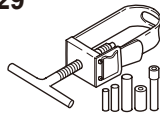
1, 2, 3 	4 	5 	6 	7 
8 	9 	10 	11 	12 
13 	14 	15 	16 	17 
18 	19 	20 	21, 22 	23, 24, 25 
26 	27 	28 	29 	

Key	Part Number	Description	Reference
1	X602-000350	T-hex. wrench (3 mm)	Removing and installing hex. head bolt (M4)
2	X602-000360	T-hex. wrench (4 mm)	Removing and installing hex. head bolt (M5)
3	X602-000230	T-hex. wrench (5 mm)	Removing and installing hex. head bolt (M6)
4	897802-33330	Tachometer PET-1000R	Measuring engine speed to adjust carburetor
5	897800-79931	Spark tester	Checking ignition system
6	91004	Module air gap gauge	Adjusting pole shoe air gaps
7	Y089-000111	Puller	Removing magneto rotor (flywheel) and crankcase
8	Y089-000094	Carburetor adjustment tool	Adjusting carburetor
9	X644-000020	Piston stopper	Locking crankshaft rotation (Fits 14 mm threads)
10	X640-000560	Clutch tool	Removing clutch assembly
11	91041	Pressure rubber plug	Plugging exhaust port to test crankcase/cylinder leakages
12	897826-16131	Pressure rubber plug	Plugging intake port to test crankcase/cylinder leakages
13	897827-16131	Pressure plate	Plugging intake port to test crankcase/cylinder leakages
14	A131-000150	Pressure connector	Testing crankcase and cylinder leakage
15	91149	Pressure/Vacuum tester	Testing crankcase / cylinder leakages
16	897803-30133	Pressure tester	Testing carburetor and crankcase leakage
17	91037	Compression gauge	Measuring cylinder compression
18	897701-14732	Bearing tool	Removing and installing ball bearings on crankcase
19	897726-21430	Oil seal tool	Installing oil seal
20	X646-000590	Collar oil seal tool	Set oil seal collect position
21	X646-000060	Rod oil seal	Installing oil seal for crankcase
22	22182-96460	Rod oil seal	Installing oil seal for crankcase
23	X646-000081	Rod bearing	Installing bearing for crankcase
24	X646-000050	Rod bearing	Installing bearing for crankcase
25	22160-96440	Rod bearing	Installing bearing for crankcase
26	22169-96410	Holder	Seat for oilseal / bearing / gearshaft
27	X643-000020	Holder	Seat for oilseal / bearing
28	X646-000100	Rod bearing	Installing bearing for crankcase (Engine cutter)
29	897702-30131	Piston pin tool	Removing and installing piston pin

2 STARTER SYSTEM

- | | |
|-------------------|------------------|
| (A) Starter case | (G) Power spring |
| (B) Rope guide | (H) Shaft |
| (C) Starter grip | (J) Cover |
| (D) Rewind spring | (K) Oil seal |
| (E) Rope reel | (L) Pawl catcher |
| (F) Starter rope | (M) Pawl |

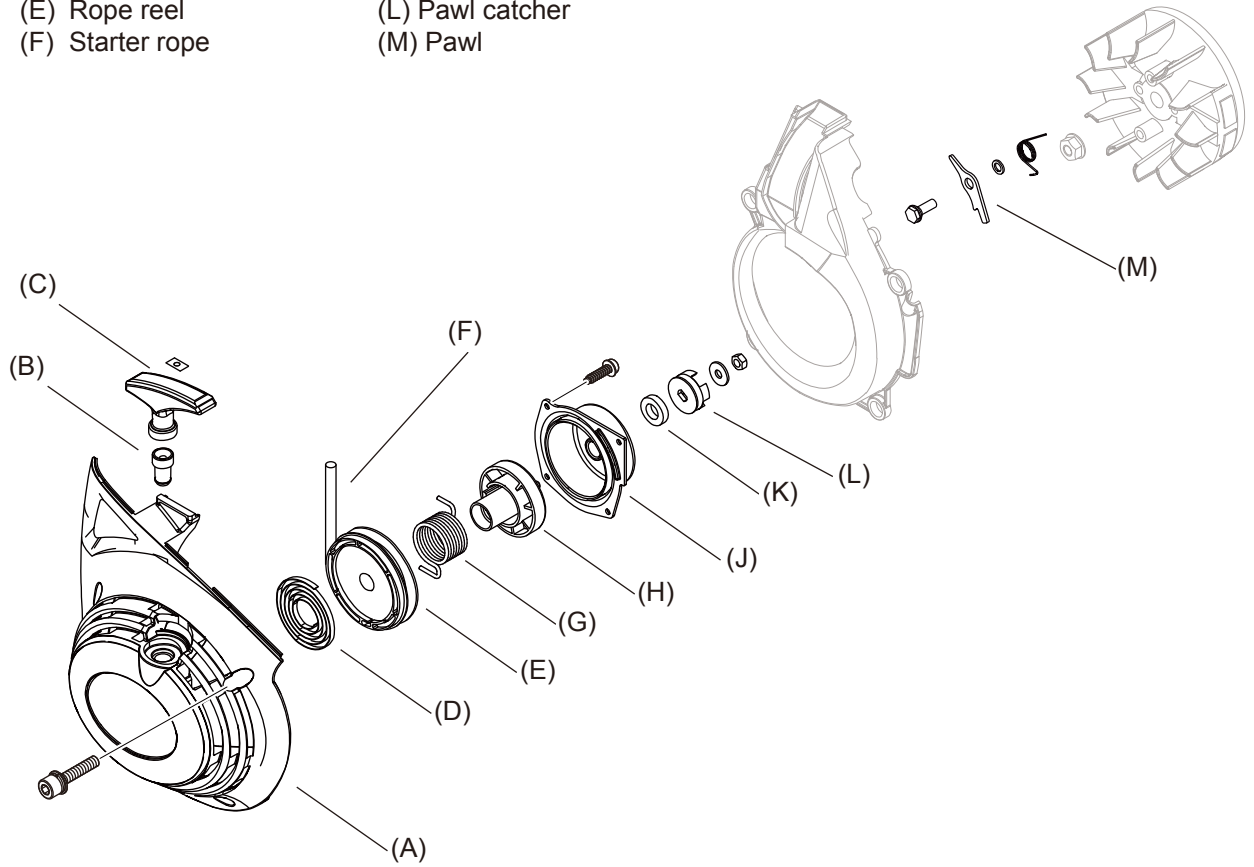

2-1 Disassembling starter assembly

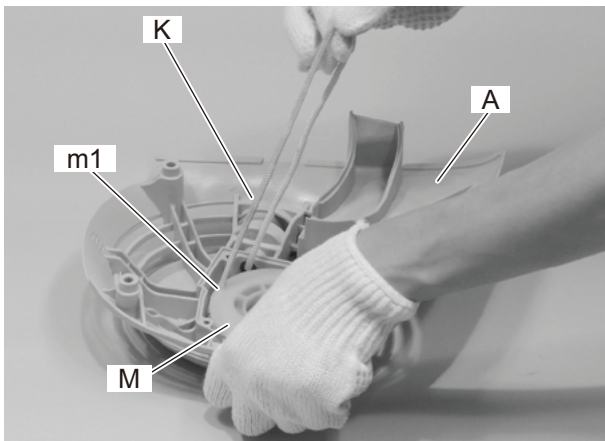
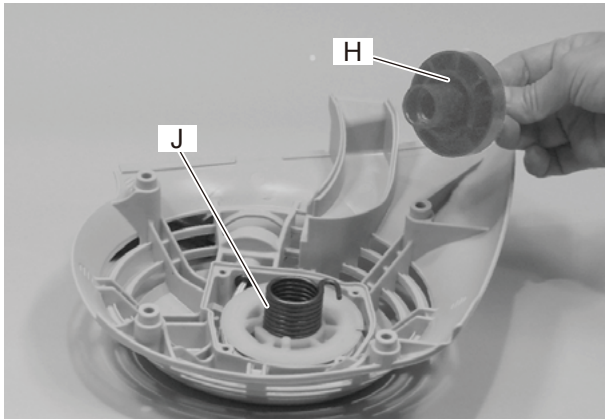
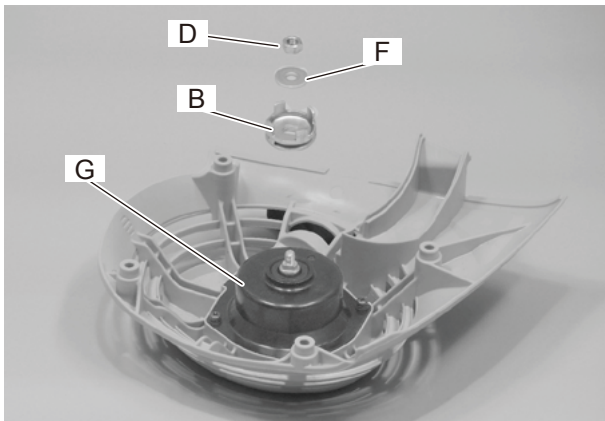
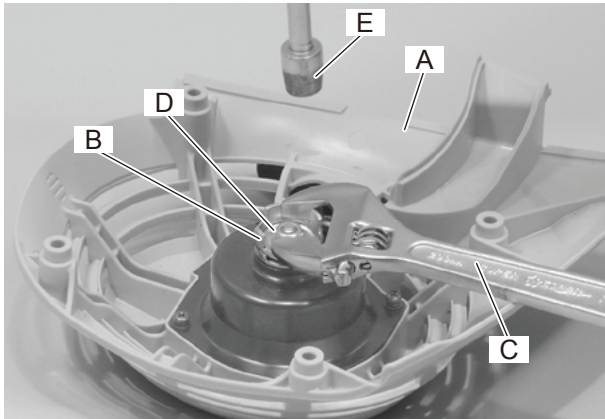

1. Remove 4 pre-coated bolts and remove starter assembly (A) from unit.

2. Pinch pawl catcher (B) with adjustable wrench (C) as shown not to rotate pawl catcher (B).

NOTE: Do not insert rod shaped tool between the pawls of pawl catcher (B) to secure it, otherwise damage of pawl catcher (B) may occur.

3. Loosen nut (D) with 10 mm socket wrench (E).

4. Remove nut (D), washer (F) and pawl catcher (B).

5. Remove 4 screws and cover (G).

NOTE: Inspect oilseal of cover (G). If damaged, replace the oilseal with new one. (Refer to "2-3 Replacing oilseal").

6. Remove shaft (H) and power spring (J).

7. Pull out starter rope (K) about 30 cm (12 in) and hold rope reel (M) by hand. Loop excess rope in rope reel notch (m1) as shown.

8. Rotate rope reel (M) counterclockwise to release tension of rewind spring.

2-1 Disassembling starter assembly (Continued)

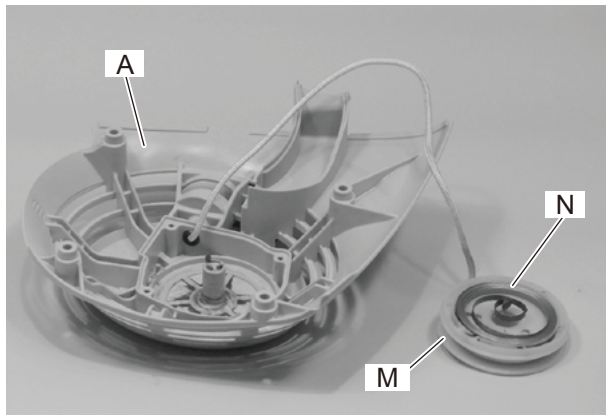

WARNING  **DANGER**
Wear eye protection and take care when removing rope reel. Rewind spring may unwind suddenly and cause personal injury.

9. Remove rope reel (M) from starter case (A) slowly to prevent rewind spring from unwinding.

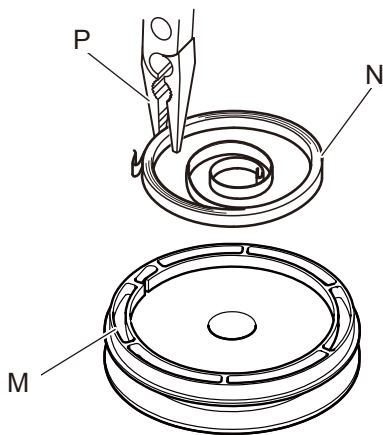

10. When removing rewind spring (N) from rope reel (M), pinch rewind spring (N) with pliers (P) and lift up as shown.

2-2 Assembling starter assembly

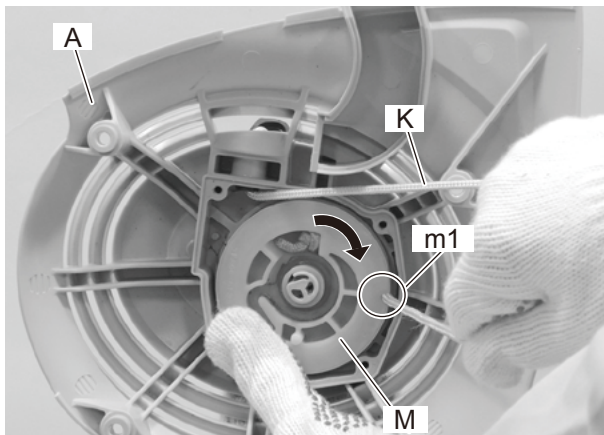
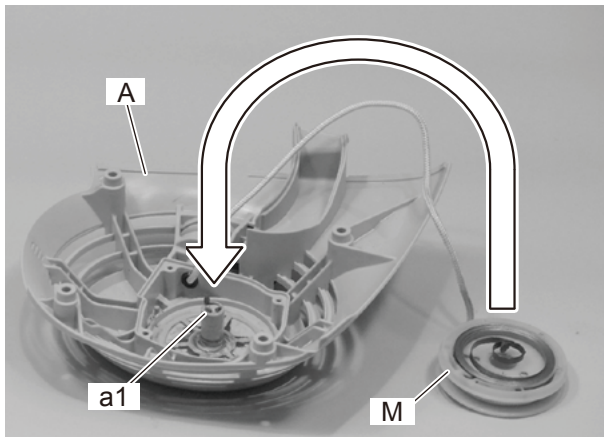
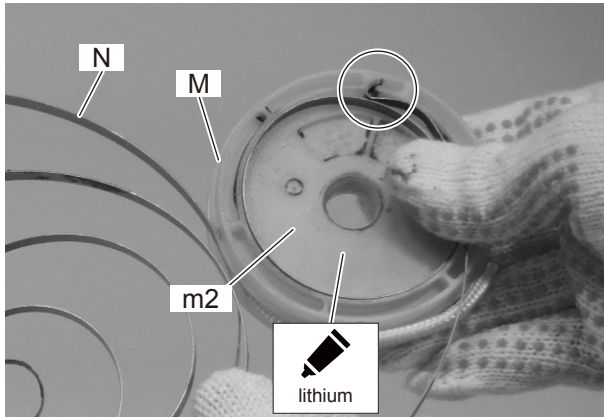
**WARNING**  **DANGER**

Use of eye protection and safety gloves are strongly recommended while working on rewind spring.

1. If rewind spring (N) is removed from rope reel (M), wind the spring (N) inside rope reel (M) as shown.

NOTE: Apply small amount of lithium based grease to surface (m2) of rope reel before winding the spring.

2. Apply lithium based grease on around shaft (a1) of starter case (A) if dry.

3. Carefully install rope reel (M) on starter case (A) as shown.

4. Pull out starter rope (K) inside starter case (A). Rotate rope reel (M) clockwise several turns with starter rope hooked at notch (m1) as shown. Hold rope reel (M) to prevent spring from unwinding and pull out starter grip to take the rope slack.

5. Pull starter grip several times to check rewind spring tension. If starter is not rewinding fully, increase spring tension by rotating rope reel (N) one more turn clockwise following above step 4.

NOTE: Lightly hold rope reel (M) by hand to prevent rewind spring from unwinding when pulling starter grip.

6. Pull out starter rope (K) all the way, and check that rope reel can be rotated an additional half or more turn clockwise as shown, to prevent rewind spring from breaking.

7. If rope reel can not be turned clockwise, reduce tension by rotating rope reel counterclockwise one turn with starter rope hooked at notch (m1).

2-2 Assembling starter assembly (Continued)

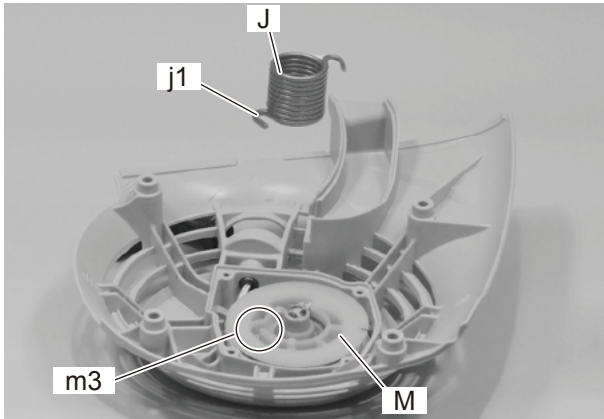

8. Install power spring (J) to rope reel (M) placing hook (j1) of power spring into groove(m3) of rope reel.

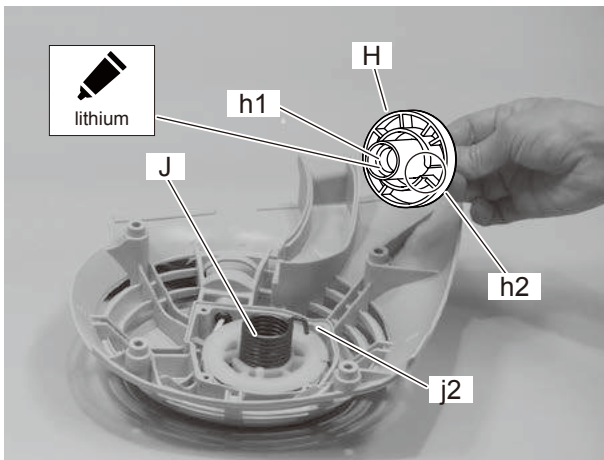

9. Apply small amount of lithium based grease to inside (h1) of shaft (H).

10. Install shaft (H) on rope reel placing hook (j2) into groove (h2).

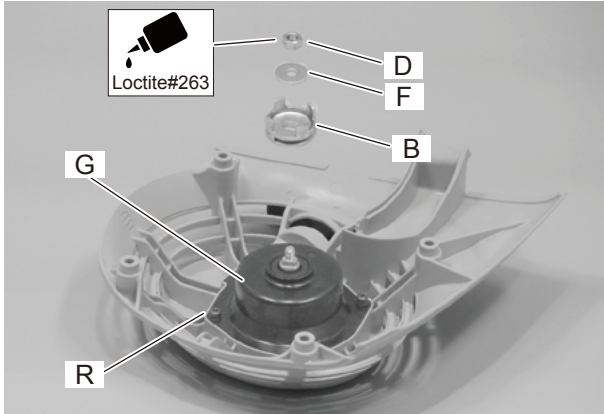

11. Place cover (G) on starter case and tighten with 4 screws (R).

12. Put washer(F) and pawl catcher (B) on cover (G).

13. Apply thread locking sealant (Loctite #263 or equivalent) to nut (D) and tighten the nut (D) by hand until it can not be turned further.

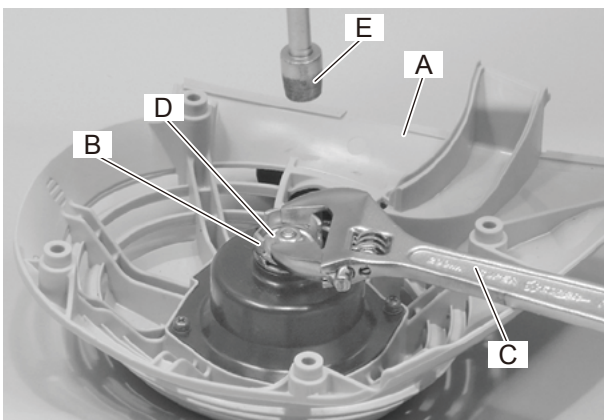

14. Pinch pawl catcher (B) with adjustable wrench (C) as shown not to rotate pawl catcher (B).

NOTE: Do not insert rod shaped tool between the pawls of pawl catcher (B) to secure it, otherwise damage of pawl catcher (B) may occur.

15. Tighten nut (D) with 10 mm socket wrench (E).

16. Reinstall starter case (A) to unit and secure starter case (A) with 4 pre-coated bolts.

NOTE: If the coat is peeled off, replace new one or apply ThreeBond #1344 or equivalent. If old thread locking sealant is left in threads, correct torque may not be secured. In case old thread locking sealant is left, remove it.

2-3 Replacing oilseal

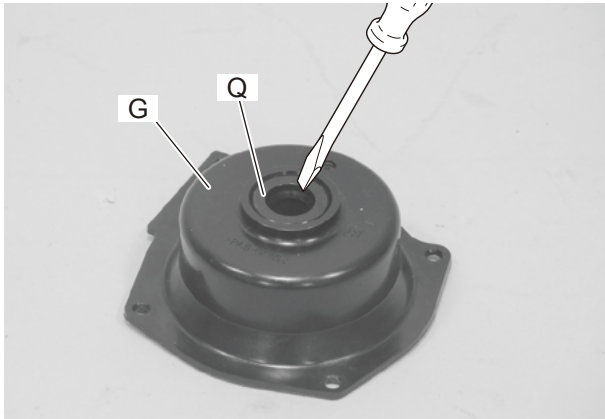

1. Remove cover (G) from starter assembly. (Refer to “2-1 Disassembling starter assembly”)
2. Pry oilseal (Q) from cover (G).
3. Install new oilseal (Q).

2-4 Replacing starter pawl

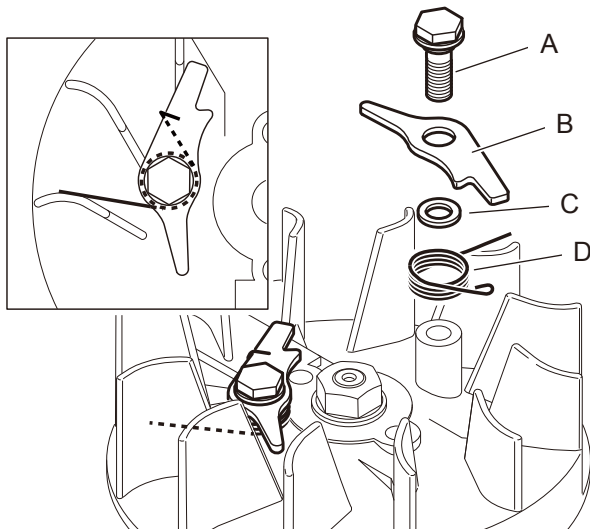

1. Remove starter assembly from unit.
2. Loosen bolt (A) with 10mm socket wrench and remove pawl (B), spacer (C) spacer (C) and torsion spring (D). Replace damaged or worn parts.

NOTE: When it is hard to loosen bolt, install piston stopper X644-000020 (E) in spark plug hole to stop crankshaft rotation and remove bolt easily.

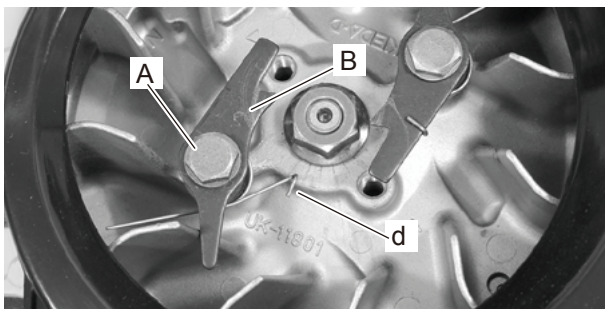
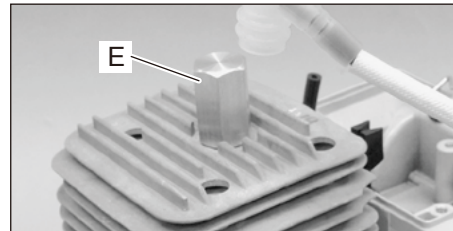

3. Install torsion spring, spacer, pawl (B) and bolt (A). To avoid torsion spring from pinching, install these parts without setting the end (d) of torsion spring on pawl (B).

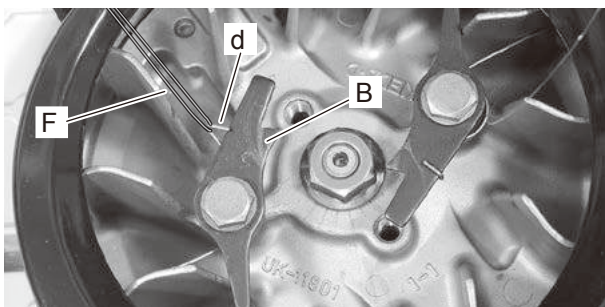

4. Using fine wire (F) or appropriate tool, place the end (d) of torsion spring on pawl (B), by hooking and passing under pawl as shown. Remove fine wire (F) or tool.

5. Make sure pawl (B) can move smoothly. If it does not move smoothly, check parts for correct installation.

3 IGNITION SYSTEM

- (A) Magneto rotor (Flywheel)
- (B) Ignition coil
- (C) Spark plug
- (D) Spark plug cap coil
- (E) Spark plug cap
- (F) Switch lead
- (G) Ignition switch

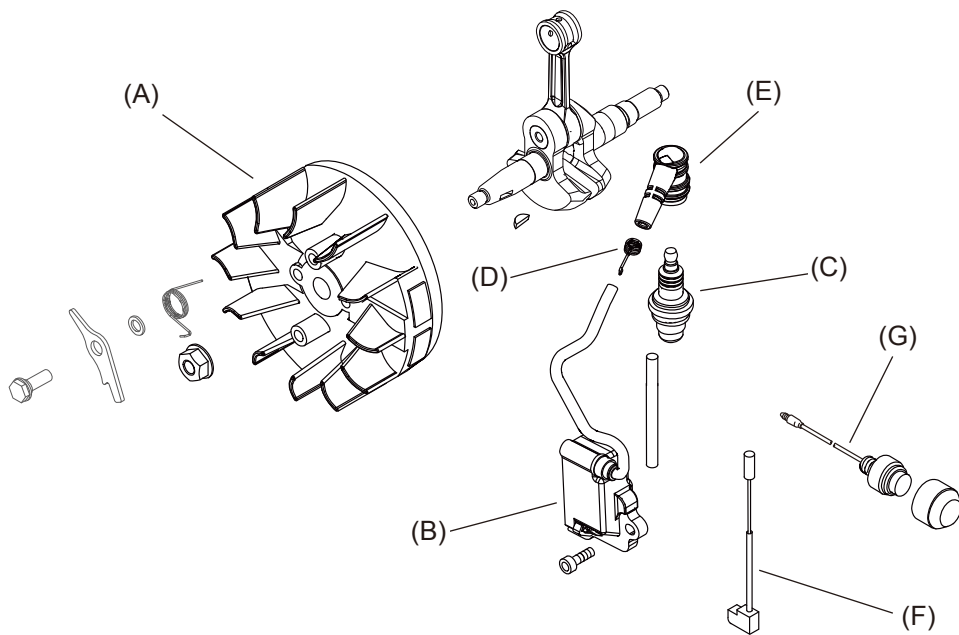

3-1 Troubleshooting guide

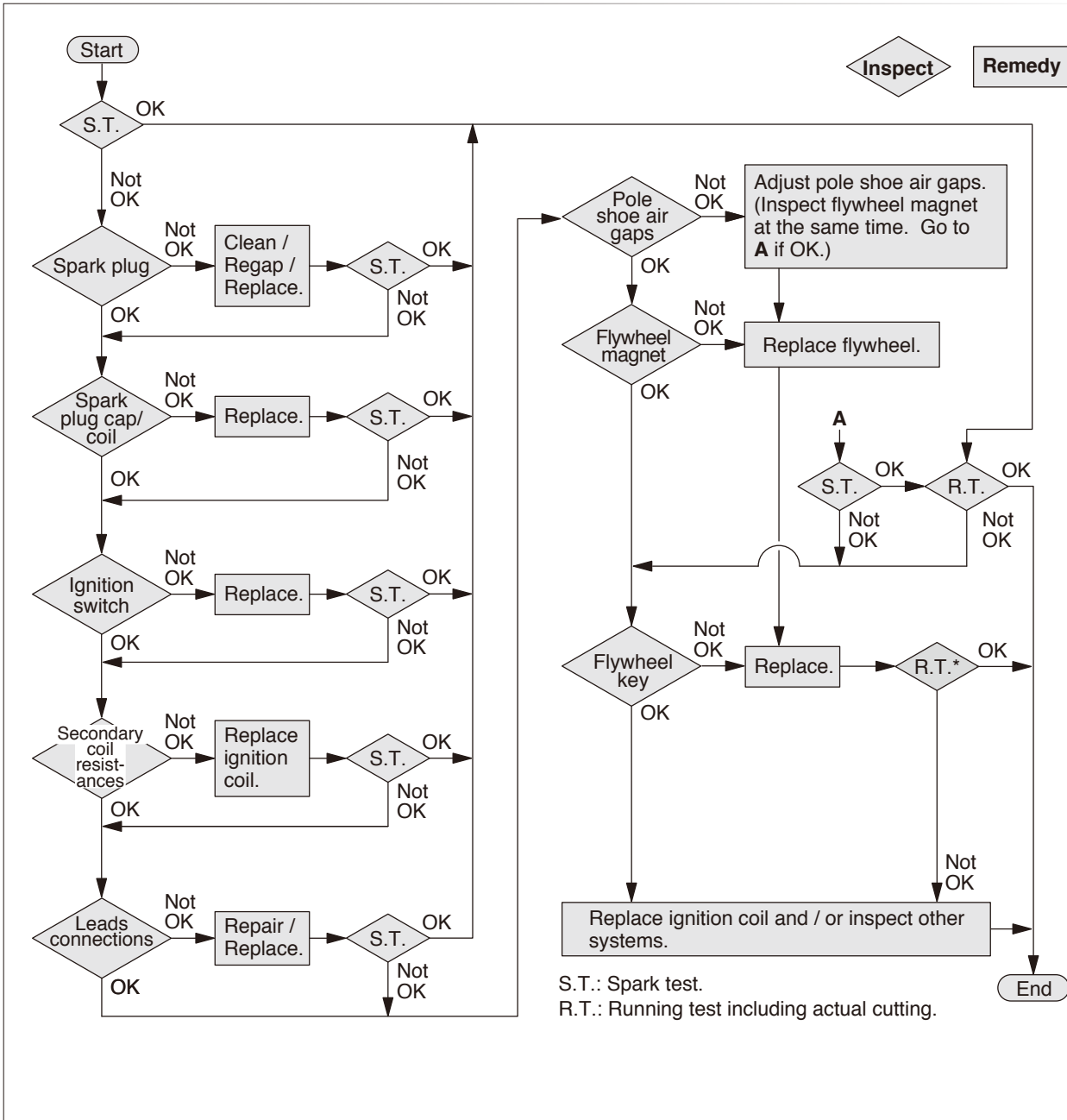

3-2 Testing spark

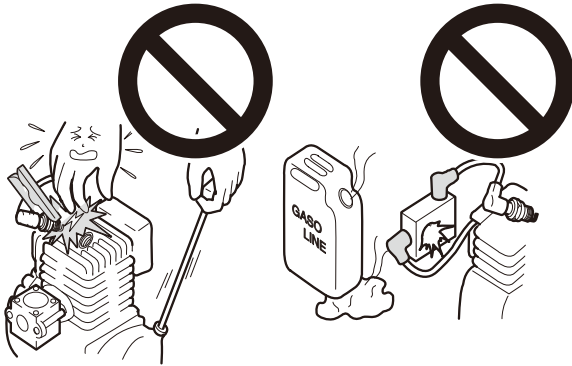

WARNING  DANGER

*Do not test near spark plug hole without spark plug installed, otherwise there is a chance to ignite fuel mixture inside cylinder.

*Do not touch metal parts of spark tester while performing the test to avoid receiving electrical shock.

*Do not check spark in area where gasoline is spilled or flammable gases may exist.

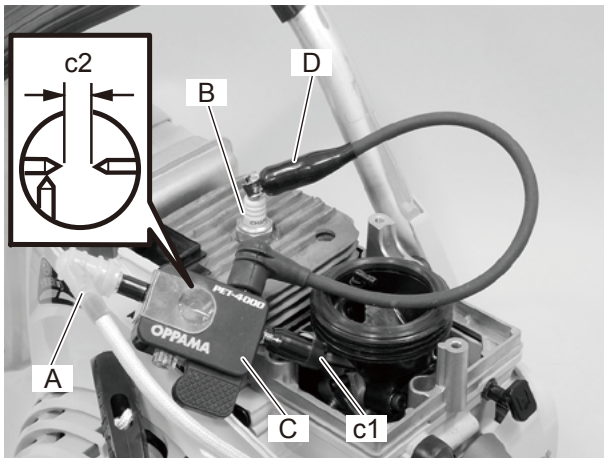

1. Remove cylinder cover. (Refer to “4-1 Replacing air filter”)
2. Connect Spark tester 897800-79931 (C) to high tension lead (A) and connect tester lead (D) to spark plug (B).
3. Screw in adjuster (c1) until the needle tips contact. Turn out adjuster (c2) 4 turns to set spark tester gap (c2) to 4 mm (0.16 in).
4. Pull starter grip several times.
5. If spark is steady blue or white at the tester gap, ignition system is considered good. Go to inspecting spark plug.
6. If no spark exists or spark is intermittent in yellow, orange, or red, continue with further inspection.

3-3 Inspecting spark plug

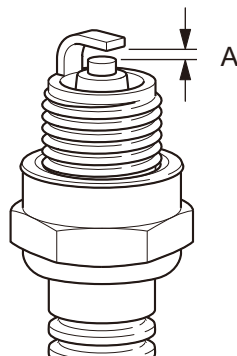

1. Remove spark plug to inspect for spark plug gap fouling, cracked or broken insulator, cracked outer electrode, or rounded center electrode. Replace spark plug as required.

Spark plug gap (A) standard
: 0.6 to 0.7 mm (0.024 to 0.028 in)

2. If engine does not start with correct spark plug, inspect if spark plug is wet or dry. If it is excessively wet or dry, inspect fuel system.

3-4 Replacing spark plug cap and coil

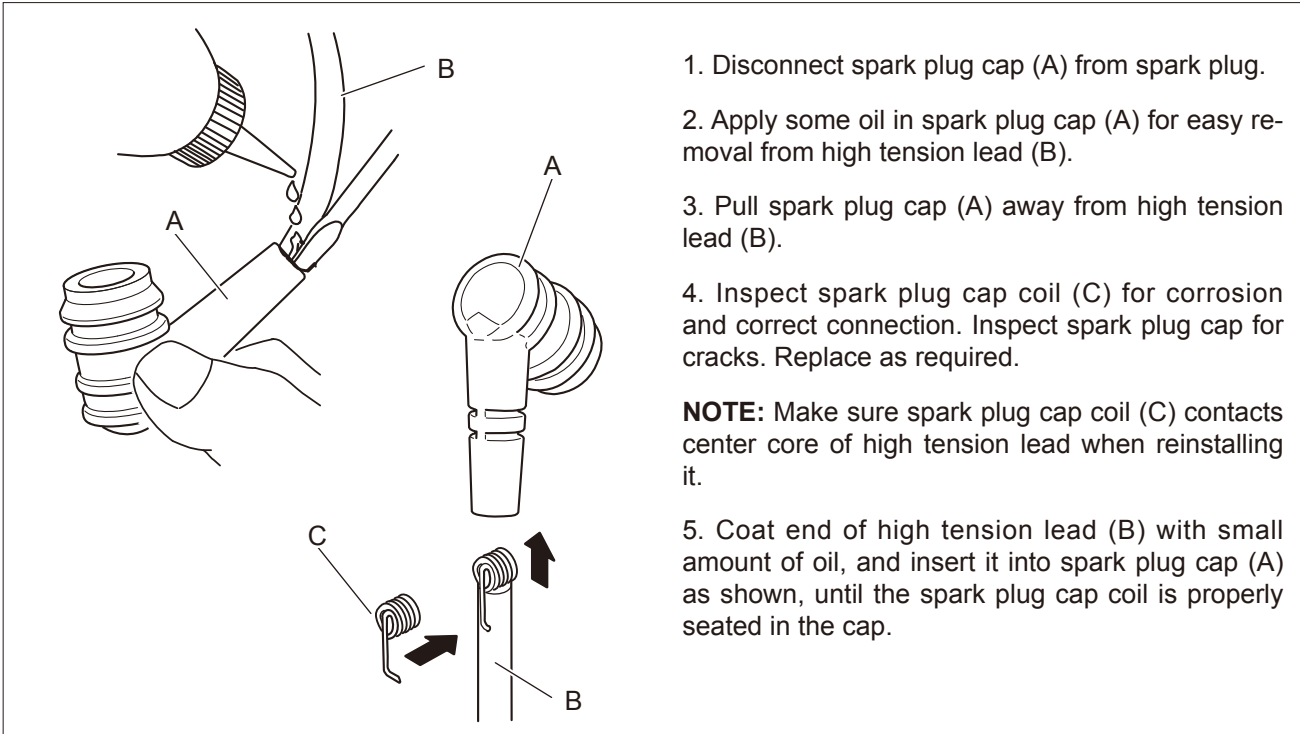

1. Disconnect spark plug cap (A) from spark plug.
2. Apply some oil in spark plug cap (A) for easy removal from high tension lead (B).
3. Pull spark plug cap (A) away from high tension lead (B).

4. Inspect spark plug cap coil (C) for corrosion and correct connection. Inspect spark plug cap for cracks. Replace as required.

NOTE: Make sure spark plug cap coil (C) contacts center core of high tension lead when reinstalling it.

5. Coat end of high tension lead (B) with small amount of oil, and insert it into spark plug cap (A) as shown, until the spark plug cap coil is properly seated in the cap.

3-5 Inspecting and replacing ignition switch

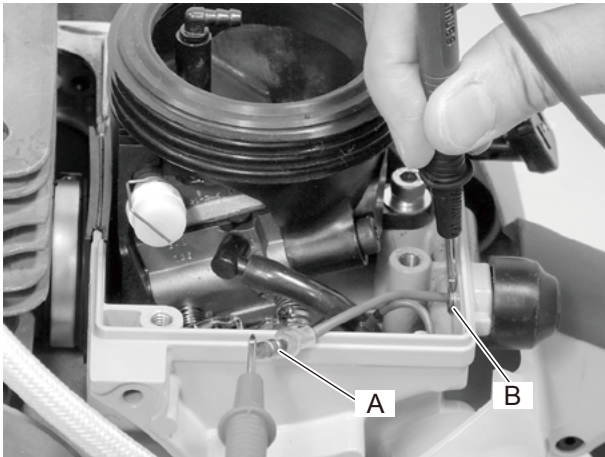

1. Remove cylinder cover assembly, filter case and cover stay. (Refer to "4-1 Replacing air filter" and "4-5 Removing carburetor, fuel line and tank vent")

2. Disconnect terminal (A) of ignition switch from switch lead.

3. Connect one probe of Ohm-meter or multi-meter to terminal (A). Connect the other probe to screw part (B) of ignition switch.

4. When not pushing ignition switch, tester should indicate infinite resistance.

5. When pushing ignition switch, tester should show that the circuit is in conducting state (closed circuit).

6. If ignition switch is defective, replace with a new one as follows.

7. Remove cap (C) and replace ignition switch.

8. Connect terminal of ignition switch and terminal of switch lead.

9. Twist leads counterclockwise and place the leads as shown.



3-6 Inspecting ignition coil and switch lead

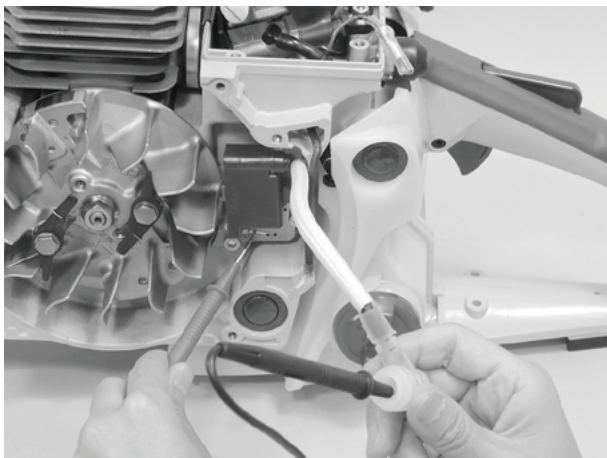

Remove cylinder cover assembly, starter assembly and fan cover.

Inspecting ignition coil resistance

1. Connect one probe of Ohm-meter or multimeter to spark plug cap coil.
2. Connect the other probe to ignition coil core to measure secondary coil resistance. Secondary coil resistance should be in the range of 1.5 to 2.5 k Ω .
3. If the meter reading indicates infinite resistance, remove spark plug cap and spark plug cap coil, and measure resistance between the conduction wire of high tension lead and ignition coil core.
5. If the reading at step 2 or 3 is not in the range of 1.5 to 2.5 k Ω , replace with a new ignition coil (Go to "3-8 Replacing ignition coil").

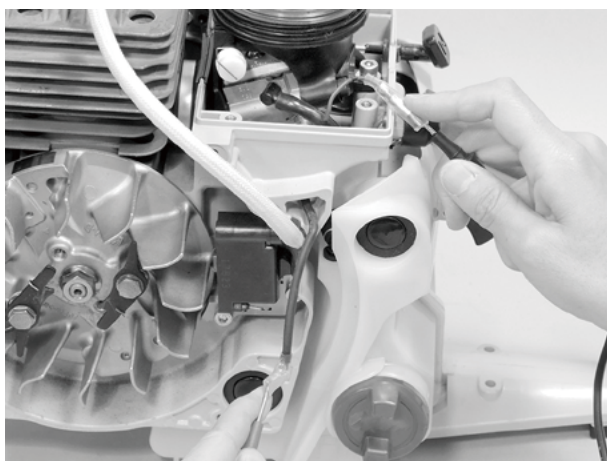

Inspecting switch lead

1. Disconnect terminals of switch lead from ignition switch and ignition coil.
2. Connect each probe of Ohm-meter or multimeter to each terminal of switch lead as shown.
3. Ohm-meter or multimeter should show that the circuit has continuity. (Electrical current can flow between each.)
4. If the meter reading indicates infinite resistance, replace switch lead with new one.

3-7 Replacing ignition coil

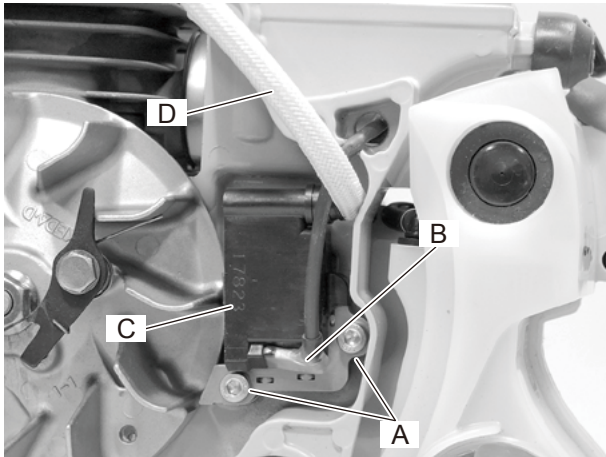

1. Remove cylinder cover assembly, filter case, cover stay (Refer to "4-1 Replacing air filter" and "4-5 Removing carburetor, fuel line and tank vent").
2. Remove starter assembly and fan cover (Refer to "2-1 Disassembling starter assembly").
3. Disconnect switch lead terminal (B) from ignition coil. Loosen 2 pre-coated bolts (A).

4. Remove ignition coil (C) from crankcase.

5. Remove spark plug cap and spark plug cap coil from high tension lead (D) (Refer to "3-4 Replacing spark plug cap and coil").

6. Install spark plug cap and spark plug cap coil to new ignition coil (C)(Refer to "3-4 Replacing spark plug cap and coil").

7. Loosely install new ignition coil (C) with 2 pre-coated bolts (A). Set air gap (Refer to "3-8 Setting pole shoe air gaps"). And then tighten 2 pre-coated bolts (A).

NOTE: If the coat is peeled off, replace new one or apply ThreeBond #1344 or equivalent. If old thread locking sealant is left in threads, correct torque may not be secured. In case old thread locking sealant is left, remove it.

8. Connect switch lead terminal (B) to ignition coil.

9. Pass high tension lead (D) over switch lead as shown.

NOTE: When reinstalling fan cover, refer to the note on page 20.

3-8 Setting pole shoe air gaps

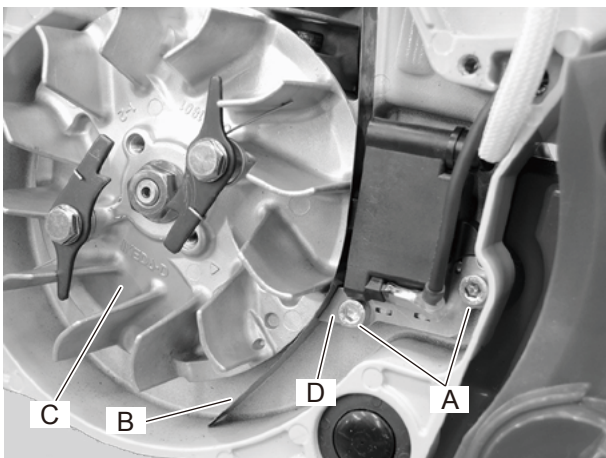

1. Insert Module air gap gauge: 91004 or 0.3 - 0.4 mm (0.012 - 0.016 in) thick feeler gauge (B) between flywheel and ignition coil shoes.

2. Rotate magneto rotor (C) until magnetic poles of magneto rotor face ignition coil shoes (D).

3. Hold ignition coil against magneto rotor (C) and tighten 2 bolts (A) to specified torque (Refer to "1-3 Torque limits"). After tightening 2 bolts (A), remove feeler gauge (B) or Module air gap gauge: 91004.

NOTE: When air gap is too narrow, contact with magneto rotor may result. When the air gap is too wide, spark is weak.

3-9 Inspecting and replacing magneto rotor and key

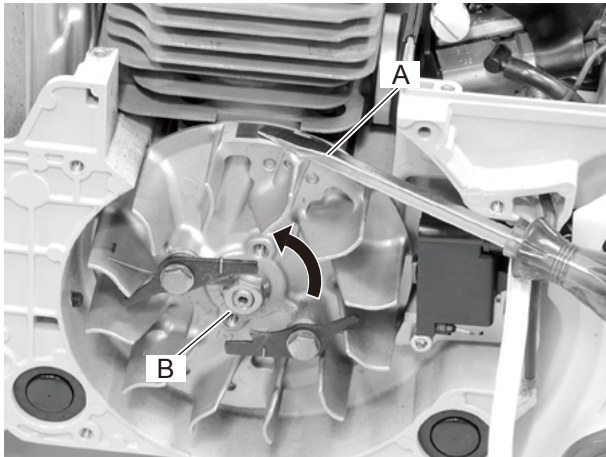

1. Inspect magnetic force of magneto rotor using flux meter, or bridging with flat head screwdriver (A) as shown.

2. If magnetic force is weak, replace flywheel as follows.

3. Install piston stopper X644-000020 (C) or clean rope into spark plug hole by hand, to stop crankshaft rotation.

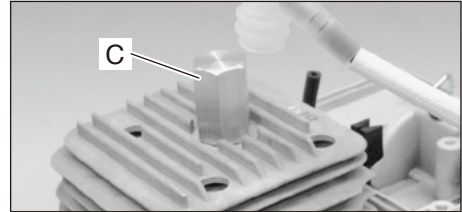

4. Remove nut (B) with 13 mm socket wrench by rotating counterclockwise.

NOTE: Do not use power tool to remove nut (B). Otherwise, piston damage may occur.

5. Screw 2 studs (E) of Puller Y089-000111 into magneto rotor as shown.

NOTE: Screw the studs (E) into magneto rotor firmly, or screw threads may be damaged.

6. Put spacer (F) of Puller Y089-000111 on the end of crankshaft as shown.

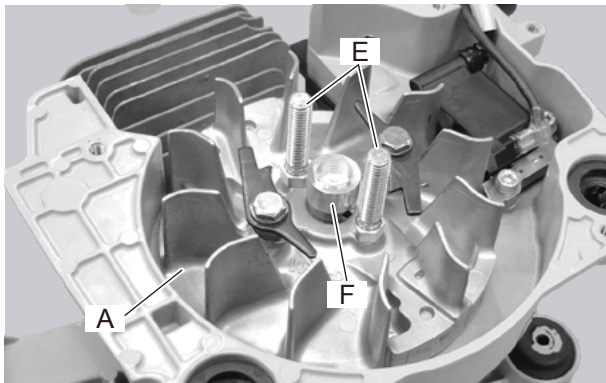

7. Put puller plate (G) as shown.

8. Tighten 2 nuts (H) on the puller alternately to remove magneto rotor (K).

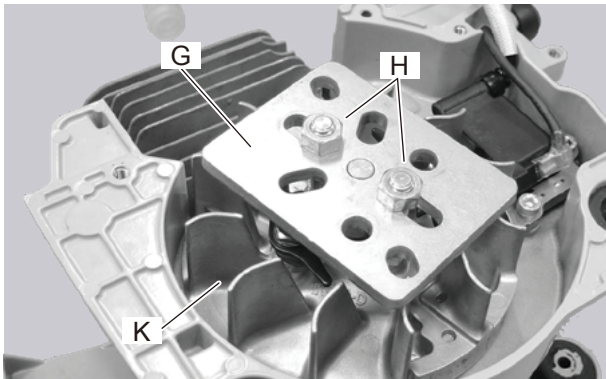

3-9 Inspecting and replacing magneto rotor and key (continued)

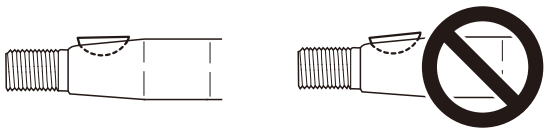
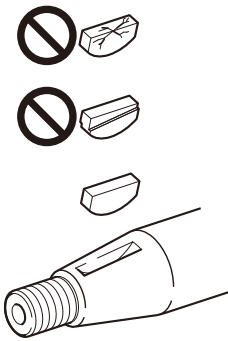

7. Inspect woodruff key for damage or shearing. Replace as required.

8. Wipe off oil from taper part of crankshaft before assembling magneto rotor.

9. Install woodruff key into key groove as shown.

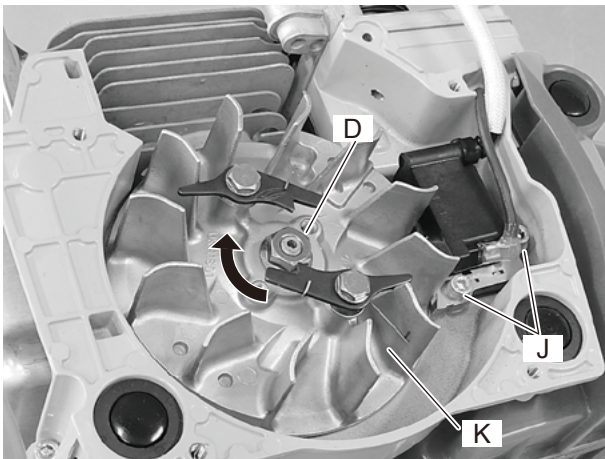

10. Align magneto rotor key groove with woodruff key on crankshaft. Install magneto rotor (K) and fasten nut (D) clockwise.

11. Loosen 2 bolts (J) and set air gap (Refer to "3-8 Setting pole shoe air gaps").

12. Retighten 2 bolts (J).

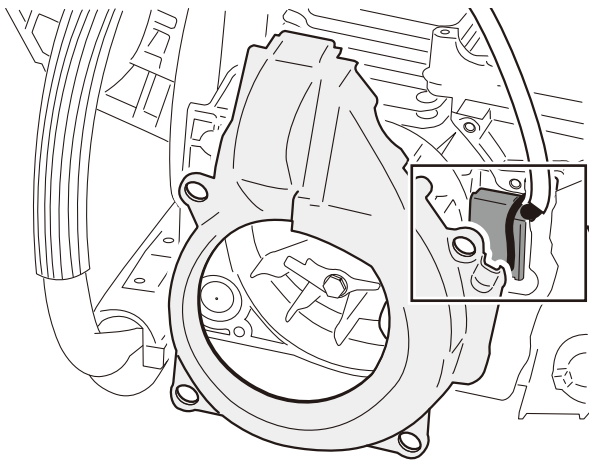

13. Reassemble all removed parts.

NOTE: When reinstalling fan cover, make sure to put high tension lead (M) in recess (N) on fan cover as shown.

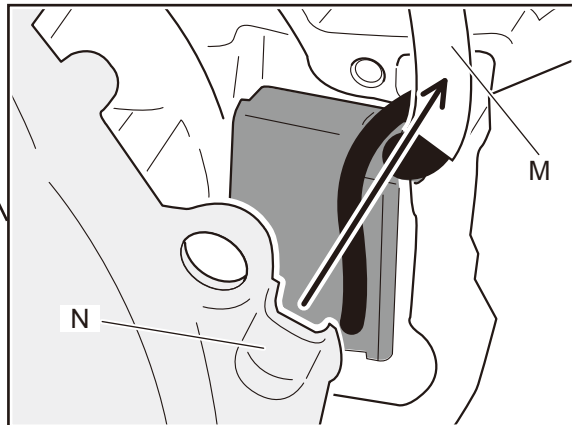

4 FUEL SYSTEM

- (A) Fuel cap
- (B) O-ring
- (C) Fuel tank vent
- (D) Fuel tank
- (E) Fuel strainer
- (F) Fuel line
- (G) Pulse line
- (H) Pressure line
- (J) Carburetor
- (K) Carburetor elbow
- (L) Intake gasket
- (M) Purge bulb
- (N) Filter case
- (P) Main air filter
- (Q) Sub air filter
- (R) Cylinder cover assembly

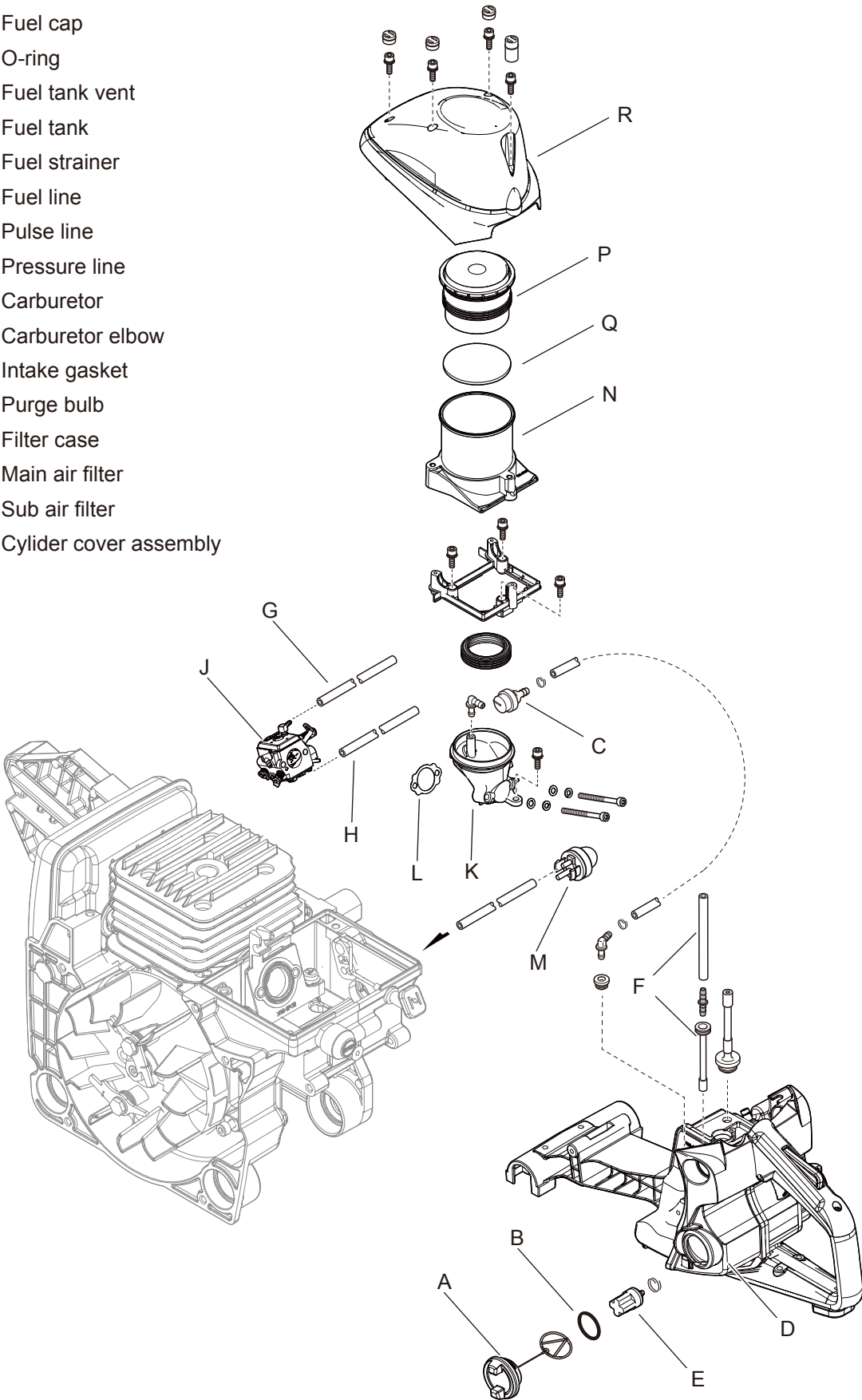

4-1 Replacing air filter

IMPORTANT: Air filters on CSG-7410ES and EC741S are designed to be maintenancefree for a long period of time. However, in the following cases the main and sub air filters should be replaced.

- When engine output drops remarkably
- After 1 year or 50 hours of operation

NOTE: Do not clean the main or sub air filters with compressed air. Otherwise, filters damage may occur.

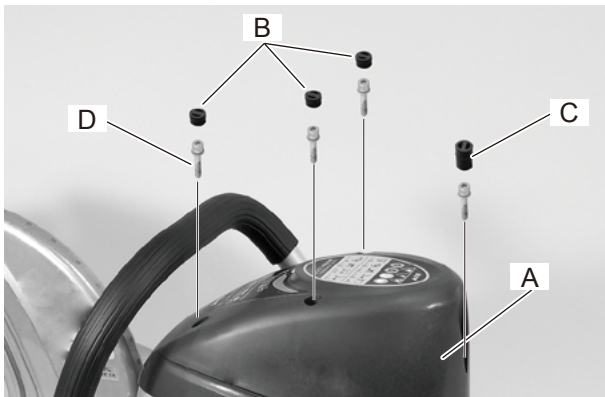

1. Remove 3 short plug grommets (B) and long plug grommet (C) pinching with longnose pliers.

2. Remove 4 pre-coated bolts (D) and cylinder cover assembly from the unit.

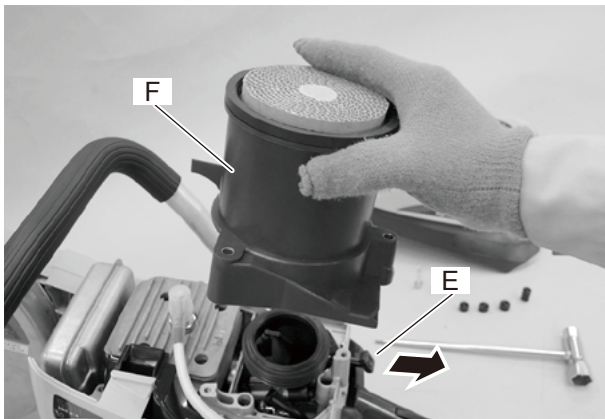

3. Close choke shutter pulling choke knob (E) to avoid dust from entering carburetor.

4. Remove filter case (F) with air filters.

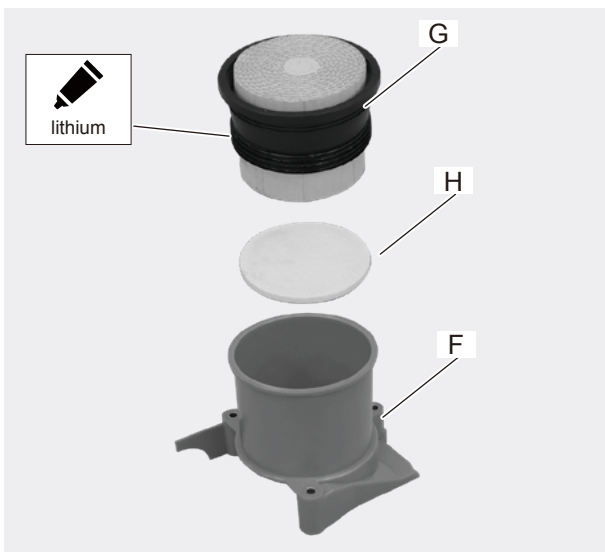

5. Remove main air filter (G) and sub air filter (H) from filter case (F).

6. Install new sub air filter (H) into filter case (F).

7. Apply small amount of lithium based grease to groove part of new main air filter (G).

8. Install new main air filter (G) into filter case (F).

9. Install filter case (F) with air filters and cylinder cover assembly (A) to the unit and tighten 4 pre-coated bolts (D).

NOTE: If the coat is peeled off, replace new one or apply ThreeBond #1344 or equivalent. If old thread locking sealant is left in threads, correct torque may not be secured. In case old thread locking sealant is left, remove it.

10. Install 3 short plug grommets (B) and long plug grommet (C) into holes of cylinder cover.

4-2 Inspecting fuel cap and fuel strainer

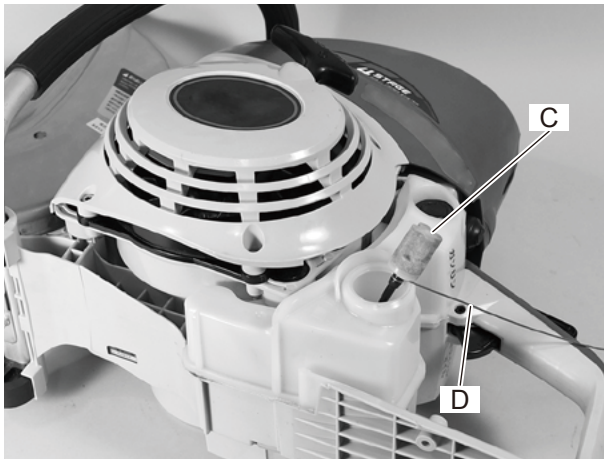
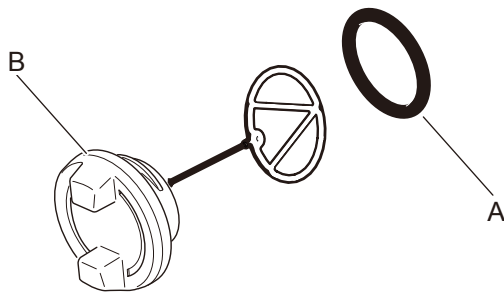

1. Remove fuel cap.
2. Inspect fuel cap for cracks and O-ring (A) for cuts or damage, and replace with a new one as required.
3. Replace fuel cap (B) if damaged.

4. Pull fuel strainer (C) from fuel tank using a wire hook (D). Replace if defective or dirty.

NOTE: If cleaner is dirty, replace to new one. Dirts in strainer can not be cleaned off and may not recover its filtering function.

5. Reinstall fuel cap.

4-3 Inspecting fuel tank and fuel line

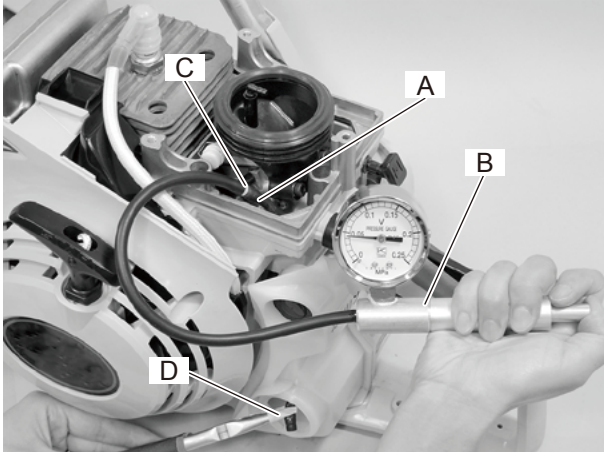

1. Clean fuel tank inside as required.
2. Remove cylinder cover and filter case (Refer to "4-1 Replacing air filter").
3. Disconnect fuel line (A) from carburetor.
4. Connect Pressure tester 897803-30133 (B) to fuel line (A).

NOTE: To connect pressure tester to fuel line, it is recommended to use pipe joint V186-000020 (C).

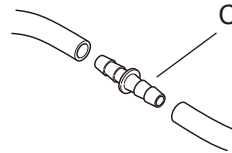

5. Remove fuel cap and pull out fuel strainer from fuel tank.
6. Pinch fuel line (D) with longnose pliers as shown.

NOTE: Wrap the ends of longnose pliers with tape (or cover with soft pipes) (D) to protect fuel line from damage.

7. Apply pressure approx. 0.05 MPa (0.5 kgf/cm²) (7 psi).
8. If pressure drops, replace fuel line (Refer to "4-5 Removing carburetor, fuel line and tank vent" and "4-13 Installing carburetor, fuel line and tank vent").
9. Put fuel strainer in fuel tank and fasten fuel cap securely.
10. Apply pressure approx. 0.01 MPa (0.1 kgf/cm²) (1.4 psi).
11. Pressure should not drop. If pressure drops, leakage may occur from fuel cap, fuel cap O-ring, mating surface of fuel tank on rear handle, grommet, or tank vent. Inspect and replace defective part(s) with new one.
12. Remove pressure tester and connect fuel line to carburetor.

4-4 Testing carburetor

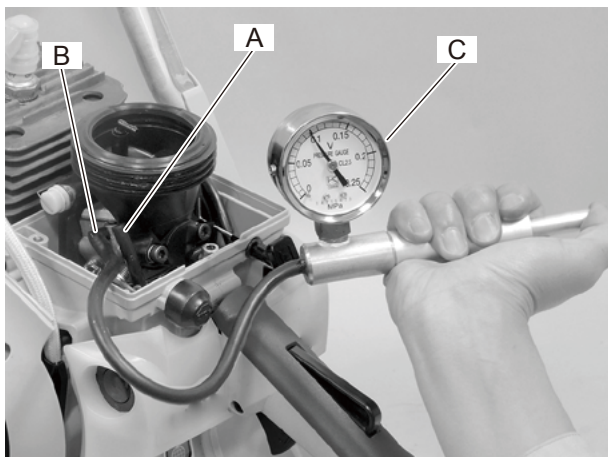

NOTE: To perform this test, carburetor interior should be wet with fuel. If dry, a little leakage may occur from diaphragms and/or inlet needle seat.

1. Remove cylinder cover assembly and filter case (Refer to “4-1 Replacing air filter”).

2. Disconnect fuel line (A) from carburetor. Connect Pressure tester 897803-30133 (C) to carburetor fuel inlet (B).

3. Apply pressure approx. 0.1 MPa (1.0 kgf/cm²) (14 psi).

4. If pressure remains steady, follow step 5 and 6. If pressure drops, proceed to step 7.

5. Lightly push purge bulb. Pressure tester reading should drop and remain above 0.05 MPa (0.5 kgf/cm²) (7 psi).

6. If reading does not drop, inspect inlet needle valve for sticking or metering lever height is too low.

7. If pressure drops at step 3, or if pressure drops below standard figure at step 5, remove carburetor from the unit (Refer to “4-5 Removing carburetor, fuel line and tank vent”).

8. Submerge carburetor in suitable clean solvent to locate the leak by applying pressure approx. 0.1 MPa (1.0 kgf/cm²) (14 psi).

9. If air bubbles come out between pump cover and carburetor body (D), inspect pump diaphragm, pump gasket, and diaphragm seat of carburetor body (Refer to “4-11 Inspecting pump diaphragm and inlet screen”).

10. If air bubbles come out from throttle bore (E), inspect inlet valve, metering lever spring, and metering lever height (Refer to “4-9 Inspecting metering chamber and inlet needle valve” and “4-10 Inspecting metering lever height”).

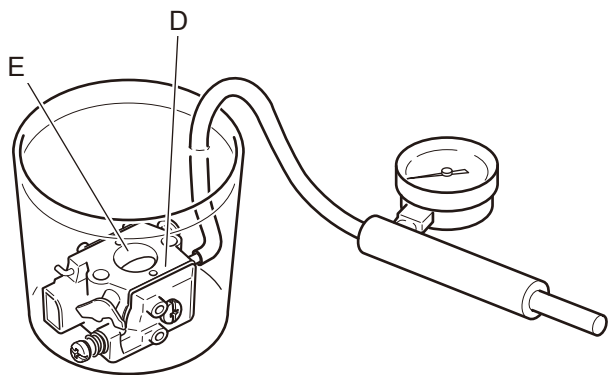

4-5 Removing carburetor, fuel line and tank vent

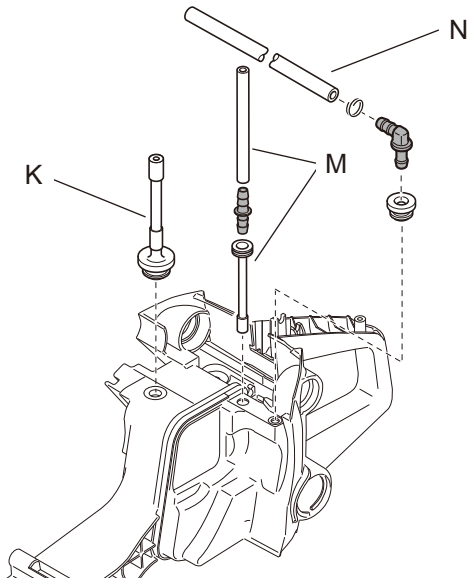
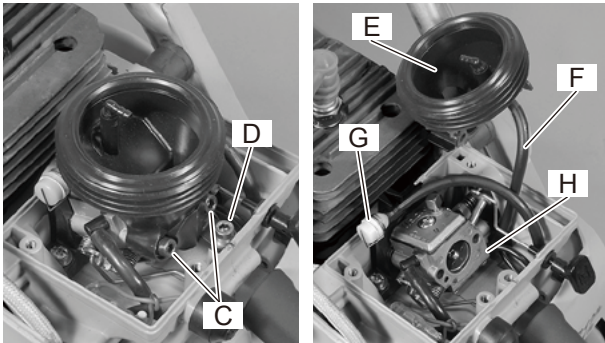
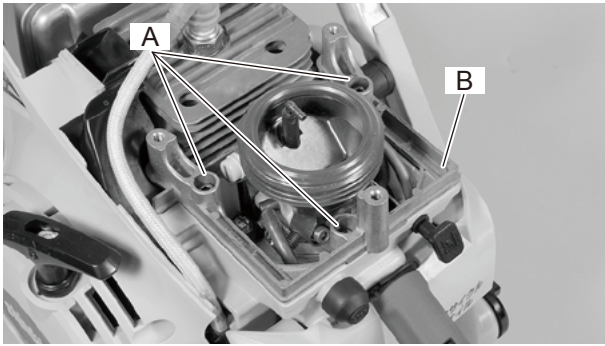

1. Remove cylinder cover assembly and filter case (Refer to "4-1 Replacing air filter").

2. Remove 3 pre-coated bolts (A) and cover stay (B)

3. Remove 2 bolts (C) and bolt (D) from carburetor elbow.

4. Disconnect pressure line (F) from carburetor elbow (E).

5. Remove tank vent (G) from vent line.

6. Disconnect fuel lines, throttle rod and choke rod from carburetor.

7. Remove starter assembly, cutter cover assembly, front handle and rear handle referring to the following section.

Starter assembly; "2-1 Disassembling starter assembly"

Cutter cover assembly; "5-2 Inspecting and replacing belt"

Rear handle; "6-1 Replacing cushions and rear handle"

7. Remove fuel cap and fuel strainer (Refer to "4-2 Inspecting fuel cap and fuel strainer").

8. Remove fuel line (M), fuel return line (K) and vent line (N) from rear handle.

4-6 Inspecting tank vent

NOTE: Tank vent prevents a vacuum from forming in fuel tank when fuel in fuel tank is being consumed. When pressure in fuel tank becomes too high, tank vent releases the pressure.

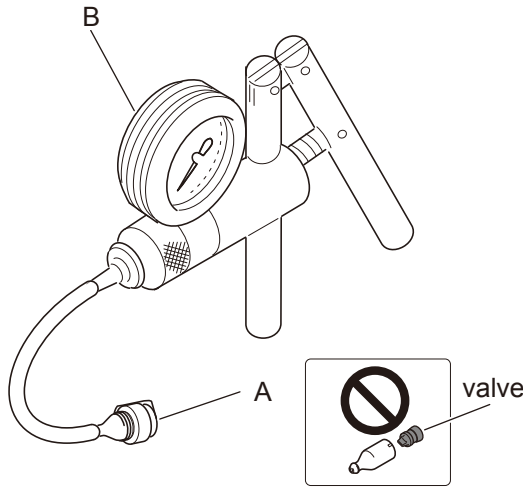

Inspection using Pressure / vacuum tester 91149

1. Remove tank vent (A) from rear handle (Refer to "4-5 Disassembling carburetor, fuel line and tank vent").
2. Connect Pressure / vacuum tester 91149 (B) to tank vent (A).
3. Apply pressure approx. 0.05 MPa (0.5 kgf/cm²) (7 psi). Make sure pressure is stable in range of 0.01 - 0.04 MPa (0.1 - 0.4 kgf/cm²) (1.4 - 5.7 psi).
4. If it is not in the range, gently clean tank vent (A) with compressed air or replace with new one.

NOTE: Do not disassemble valve in tank vent assembly. Damage to valve will occur.

5. Apply negative pressure 0.02 MPa (0.2 kgf/cm²) (3 psi).

6. Tank vent should pass air freely without holding any pressure. If it does not, replace tank vent with new one.

Inspection using Pressure tester 897803-30133

If Pressure / vacuum tester 91149 is not available, tank vent can be inspected with Pressure tester 897803-30133 as follows.

1. Connect tank vent (A) to Pressure tester 897803-30133 (D).
2. Apply pressure approx. 0.05 MPa (0.5 kgf/cm²) (7 psi), make sure pressure is stable in range of 0.01 - 0.04 MPa (0.1 - 0.4 kgf/cm²) (1.4 - 5.7 psi).

3. If it is not in the range, gently clean tank vent with compressed air or replace with new one.

NOTE: Do not disassemble valve in tank vent assembly as shown. Damage to valve will occur.

4. Remove wire (E), filter (F) and cap (G) from tank vent and clean sponge (H).

5. Cut pipe 363011-00210 (J: 7x11x170mm) and 382011-01110 (K: 9x13x350) in approx. 30mm (1 1/4 in) length, and connect them to pressure tester as shown. Connect tank vent without cap to pipe as shown.

6. Plug hole (a) with finger and apply pressure 0.2 MPa (0.2 kgf/cm²) (3 psi). The pressure should hold steady.

7. Remove finger from hole (a). Tank vent should pass air freely without holding any pressure. If it does not, replace tank vent with new one.

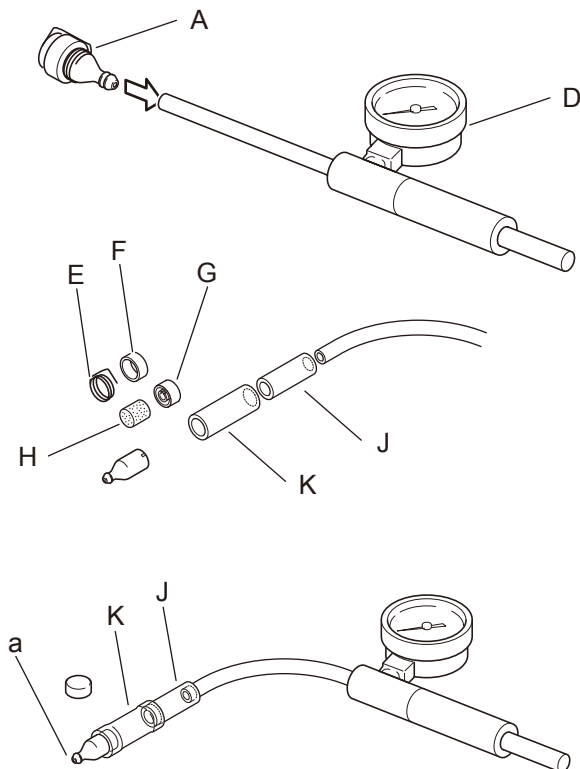

4-7 Replacing purge bulb

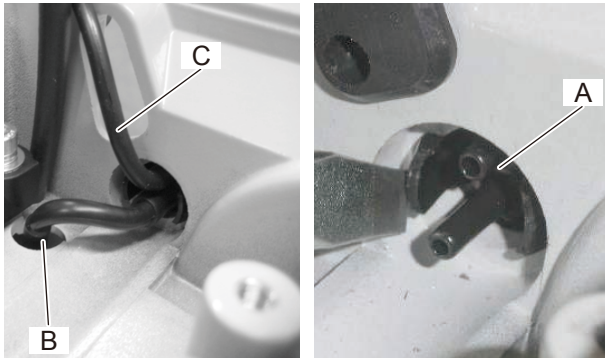

1. Remove carburetor from unit (Refer to “4-5 Removing carburetor, fuel line and tank vent”).
2. Disconnect fuel return line (B) and purge line (C) from purge bulb (A).
3. Press leg of purge bulb (A) with appropriated tool and remove the purge bulb.
4. Install new purge bulb.

4-8 Inspecting crankcase pulse passage

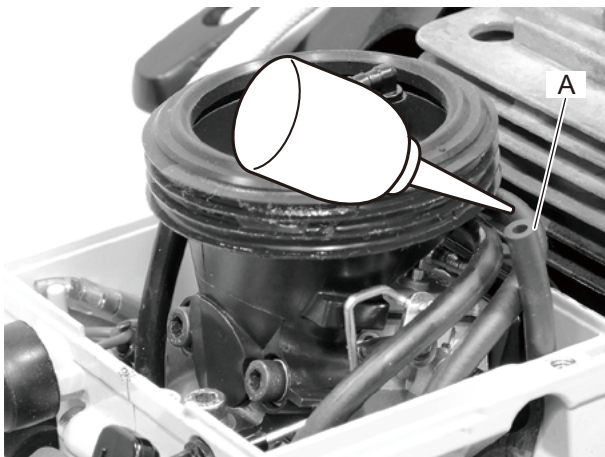
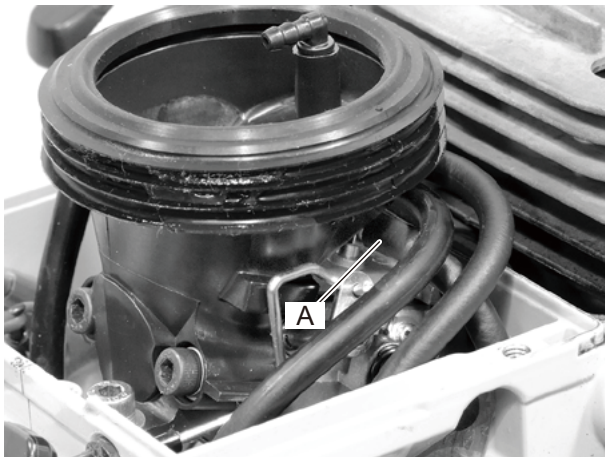

1. Remove cylinder cover assembly, filter case and cover stay (Refer to “4-1 Replacing air filter” and “4-5 Removing carburetor, fuel line and tank vent”).
2. Disconnect pulse line (A) from carburetor.
3. Drop a little 2 stroke oil in the end of pulse line (A) as shown.
4. Remove spark plug and pull starter grip several times. Oil should spit back from the hole of pulse line.

WARNING  **DANGER**

Always remove spark plug cap from spark plug before pulling starter rope for maintenance or repairing. Otherwise, serious personal injury can result. Because ignition switch installed on this unit automatically returns to RUN position, Engine may start unintentionally.

5. If not, inspect whether pulse passage is clogged. Repair or replace as required.

4-9 Inspecting metering chamber and inlet needle valve

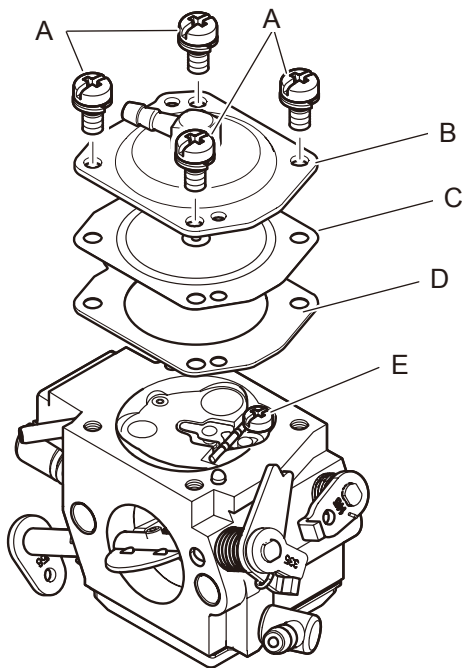

1. Remove 4 screws (A), metering diaphragm cover (B), metering diaphragm (C) and gasket (D).
2. Inspect metering diaphragm (C) for hardening, distortion or pin hole. Replace as required.
3. Inspect metering gasket (D) and replace if defective.

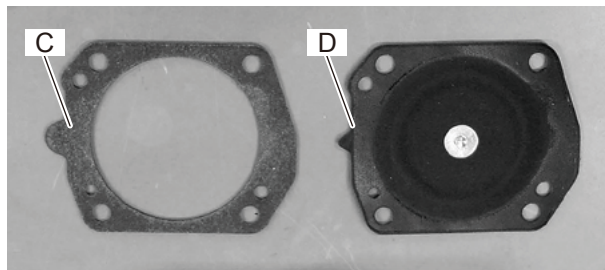

4. Loosen screw (E) and remove metering lever (F), metering lever pin (G), metering lever spring (H) and inlet needle valve (J).

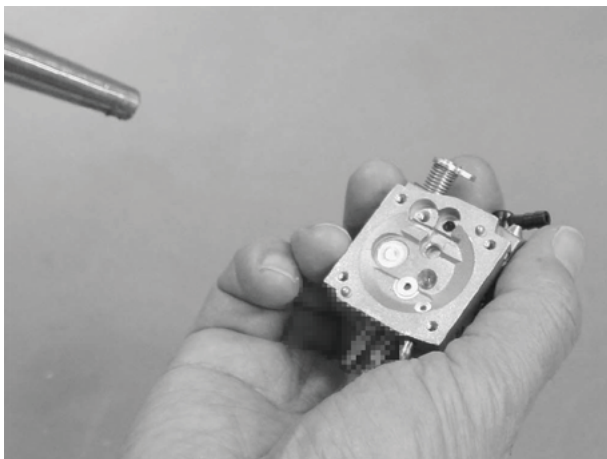
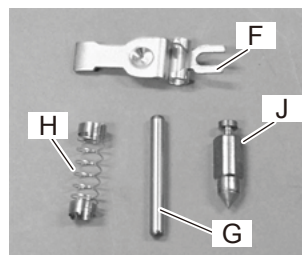

5. Clean fuel passages in carburetor body with compressed air.

NOTE: Before cleaning metering side with compressed air, turn "H" needle clockwise until lightly seated and remove inlet needle valve. Otherwise, main nozzle check valve and inlet needle valve spring may be damaged by the compressed air.

4-9 Inspecting metering chamber and inlet needle valve (Continued)

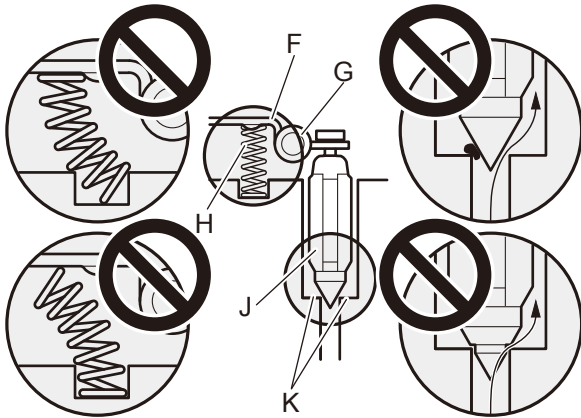

6. Inspect inlet needle valve (J) if worn or sticky. Clean or replace as required.

7. Clean inlet needle valve seat (K) using suitable clean solvent (do not use metal tools).

NOTE: Causes of fuel flooding from carburetor to cylinder are as follows:

- Improper assembling of metering lever (F) and spring (H).
- Dirt between inlet needle valve (J) and valve seat (K).
- Worn inlet needle valve tip.

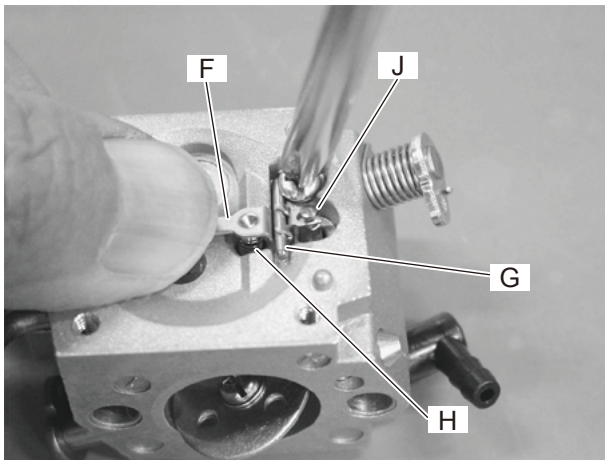

8. Reassemble inlet needle valve (J), spring (H), metering lever (F) and metering lever pin (G).

NOTE: Insure proper metering lever installation as follows.

- (1) Spring (H) is seated in its hole at chamber floor.
- (2) Spring (H) is under dimple of metering lever.
- (3) Metering lever fork is holding inlet needle valve (J).

9. Inspect metering lever height and adjust the height as required (Refer to "4-10 Inspecting metering lever height").

4-10 Inspecting metering lever height

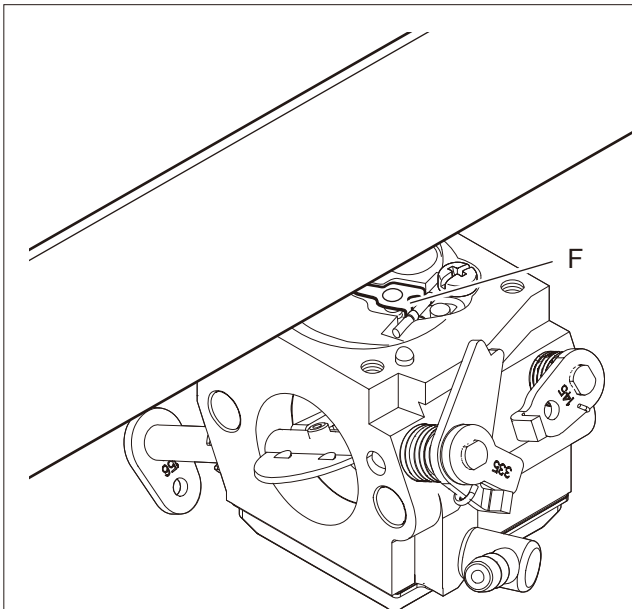

1. Inspect metering lever (F) height as shown. Metering lever height should be flush with diaphragm seat.

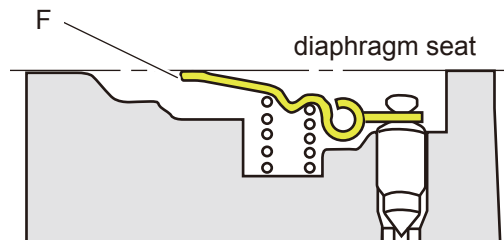

2. If necessary, gently bend metering lever (F) up or down to set metering lever to proper position.

NOTE: When metering lever is:

Too high → Fuel flooding occurs

Too low → Fuel starvation / overheating occurs

4-11 Inspecting pump diaphragm and inlet screen

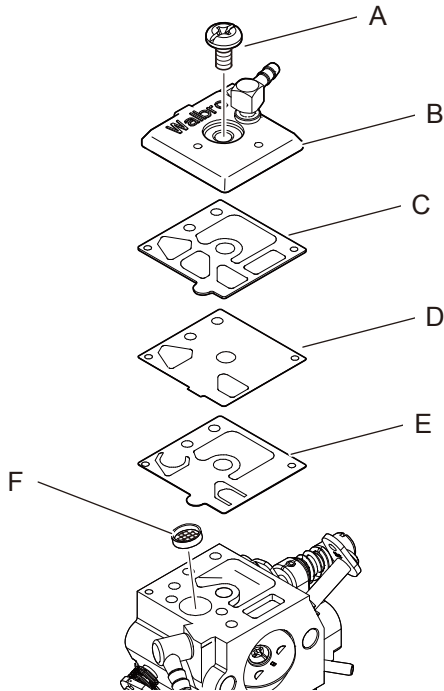

1. Remove screw (A), pump cover (B), pump gasket (C), pump diaphragm (D) and (E).
2. Inspect pump diaphragm (D) and (E). Replace if hardened or curled at valve tabs.
3. Inspect pump gasket (C). Replace if defective.
4. Inspect inlet screen (F). If blocked, remove and clean it, or replace.

NOTE: When cleaning pump side with compressed air, take care not to blow inlet screen (F) away.

4-12 Replacing welch plug

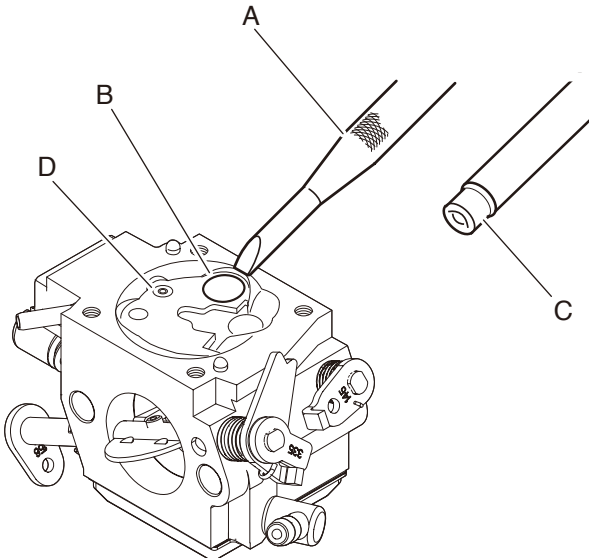

If engine does not run smoothly even after readjusting carburetor and inspecting carburetor parts, inspect low speed ports on carburetor as follows:

1. Remove metering lever and related parts to protect them from damage (Refer to "4-9 Inspecting metering chamber and inlet needle valve").
2. To remove welch plug (B), punch the remover tool (A) through welch plug at low angle and pry it out.

NOTE: Remover tool (A) and welch plug installer (C) are included in Welch plug tool kit (Part number: 500-500).

3. Clean low speed ports with compressed air.
4. Place a new welch plug (B) over the opening and gently tap it until flush using welch plug installer (C).
5. Install all removed parts to carburetor body.

4-13 Installing carburetor, fuel line and tank vent

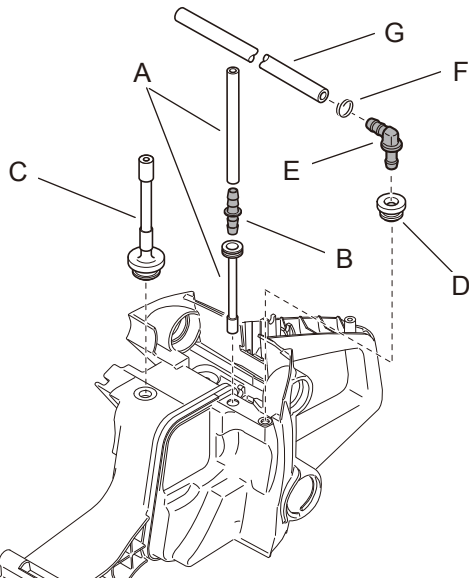

1. Install fuel line (A), pipe joint (B), fuel return line (C), grommet (D), pipe joint (E), clip (F) and vent line (G) to rear handle as shown.

NOTE: Make sure to pass fuel line (A) through groove of rear handle as shown.

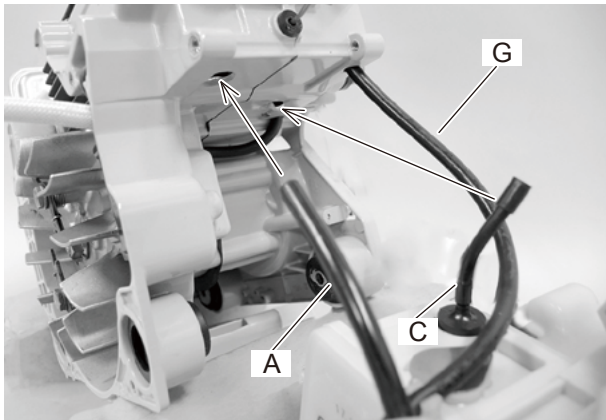
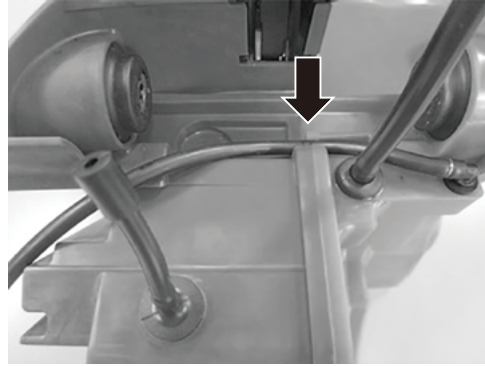

2. Pass fuel line (A), fuel return line (C) and vent line (G) through holes of crankcase as shown.

3. Install rear handle to crankcase (Refer to "6-1 Replacing cushions and rear handle").

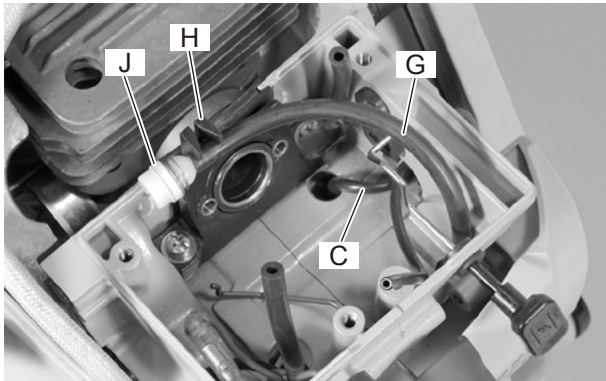

4. Connect fuel return line (C) to long leg of purge bulb.

5. Hold vent line (G) on intake insulator (H) as shown.

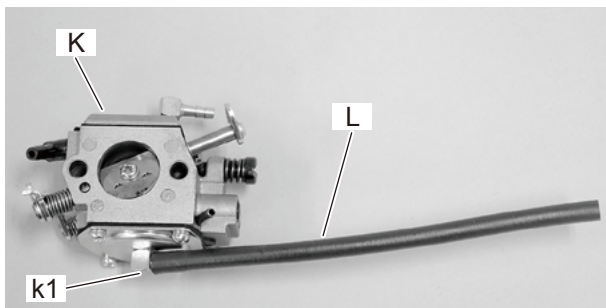

6. Connect pressure line (L) to joint (k1) on carburetor (K) as shown.

4-13 Installing carburetor, fuel line and tank vent (Continued)

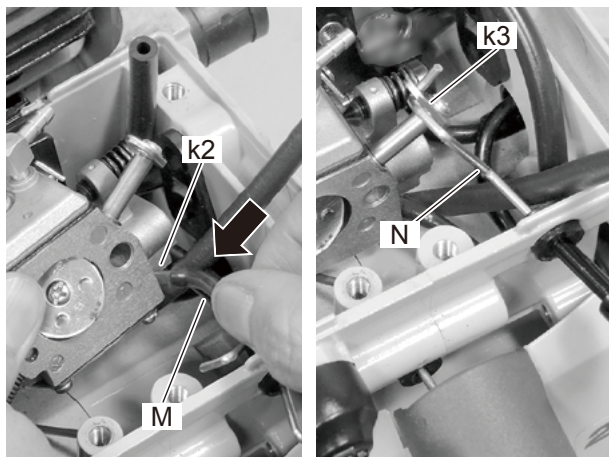

7. Connect fuel return line (M) to fuel outlet (k2) on carburetor.

8. Connect choke rod (N) to choke lever (k3) on carburetor as shown.

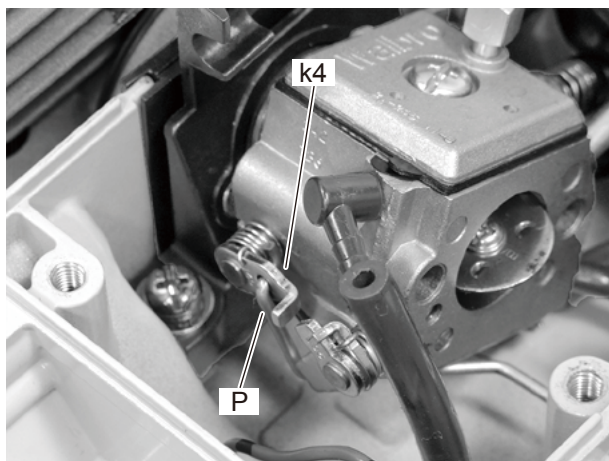

9. Connect throttle rod (P) to throttle lever (k4) on carburetor as shown.

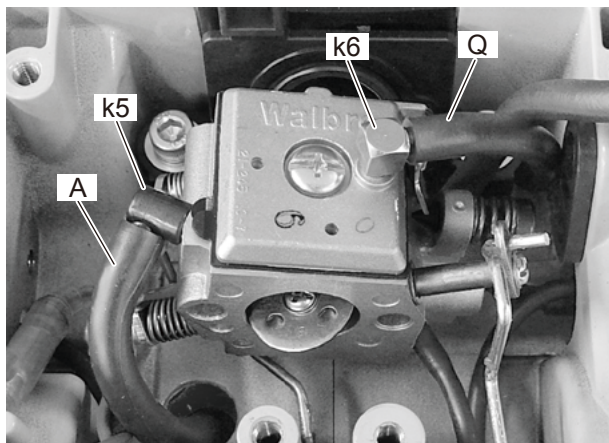

10. Connect fuel line (A) to fuel inlet (k5) on carburetor.

11. Connect pulse line (Q) to joint (k6) on carburetor.

4-13 Installing carburetor, fuel line and tank vent (Continued)

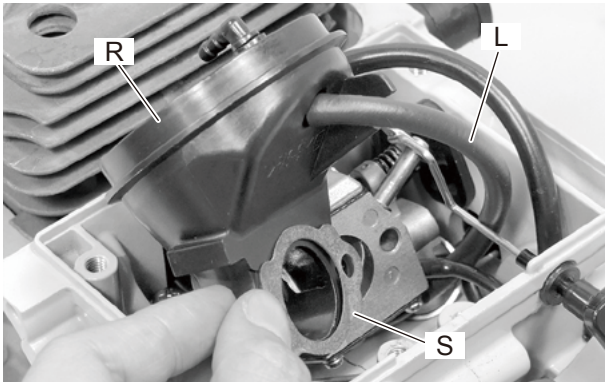

12. Connect pressure line (L) to joint of carburetor elbow (R).

13. Place intake gasket (S) on carburetor elbow (R) as shown.

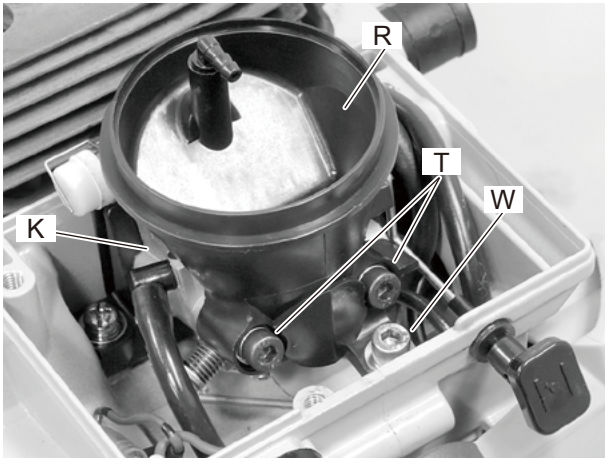

14. Secure carburetor elbow (R), intake gasket (S) and carburetor (K) with 2 bolts (T), 2 spring washers (U), 2 washers (V) and pre-coated bolt (W) as shown.

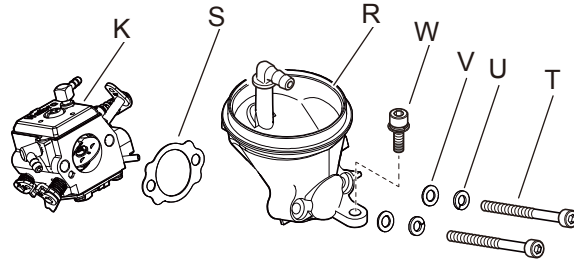

NOTE: If the coat is peeled off, replace new one or apply ThreeBond #1344 or equivalent. If old thread locking sealant is left in threads, correct torque may not be secured. In case old thread locking sealant is left, remove it.

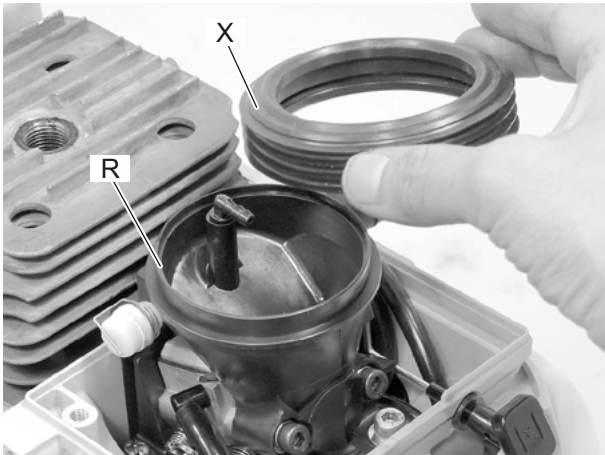

15. Install seal (X) to carburetor elbow (R).

4-14 Adjusting carburetor

4-14-1 General adjusting rules

A. Before adjustment, check the following items.

1. The correct spark plug must be clean and properly gapped.
2. The air filters must be clean and properly installed.
3. The muffler exhaust port must be clear of carbon.
4. The fuel lines, tank vent and fuel strainer are in good condition and clear of debris.
5. The fuel is fresh (> 89 octane : RON) and properly mixed at 50 : 1 with "ISO L-EGD" or "JASO FC/FD" 2-stroke oil.

B. Preliminary adjustment. Adjustment by Throttle adjust screw of carburetor.

Start and run engine for 120 seconds alternating engine speed between WOT 5 seconds and idle 10 seconds. Verify idle engine speed ranges from 2,600 to 3,000 r/min. If idle engine speed is out of range, adjust throttle adjust screw to 2,600 - 3,000 r/min. If engine does not run correctly after this adjustment, proceed to the next step 4-14-2.

NOTE: CSG-7410ES and EC741S have over rev. limiter with ignition control at around WOT engine speed. Therefore, pulsetype tachometer, such as PET-1000R and PET-304, can not indicate correct WOT engine speed. When adjusting WOT speed, adjust H mixture needle referring "4-14-2 Initial setting Throttle adjust screw, L mixture needle and H mixture needle".

4-14-2 Initial setting Throttle adjust screw, L mixture needle and H mixture needle

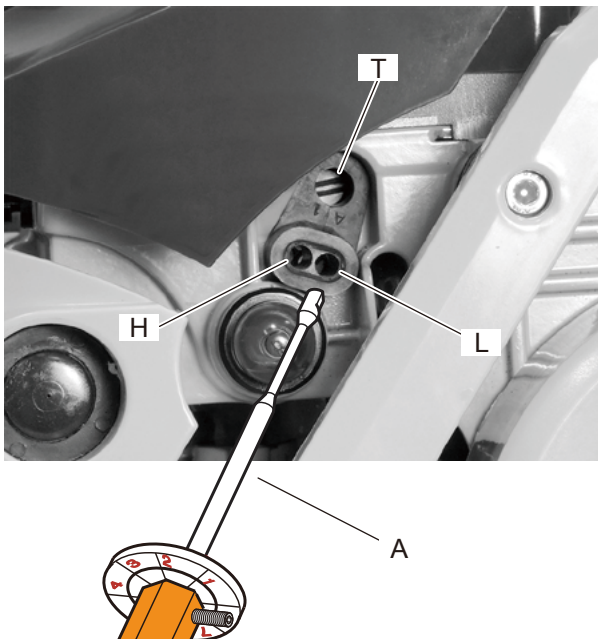

Tools required : P/N 897802-33330 Tachometer PET-1000R, P/N Y089-000095 Carburetor adjustment tool (Large D-shaped tool (A))

1. Turn L and H mixture needles and Throttle adjust screw clockwise until lightly seated, and then turn out both mixture needles and throttle adjust screw following turns.

L mixture needle (L) : 2

H mixture needle (H) :

3 1/2 (Mixed two-stroke regular fuel)

3 3/8 (Premixed alkylate fuel)

Throttle adjust screw (T) : 2 1/2

NOTE: If needles are overtightened during seating, damage to carburetor may occur.

NOTE: The initial carburetor settings for throttle adjust screw and L mixture needles are intended to start and run the engine before final carburetor adjustments are made to conform the unit to meet Emission Directive. The actual number of turns needed for engine operation may vary. On the other hand, setting of H mixture needle is as described above and no adjustment during setting procedure. Therefore Don't turn H mixture needle after initial setting.

4-14-3 Adjusting carburetor

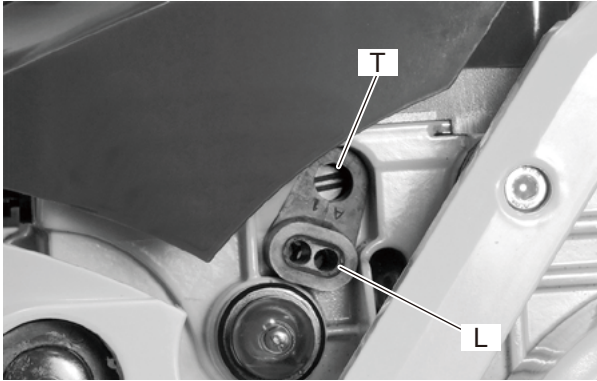

1. Remove cutter blade from unit.

NOTE: Cutter blade can affect setting of idle maximum speed.

2. Start and run engine for 120 seconds alternating engine speed between WOT 5 seconds and idle 10 seconds.

3. Adjust L mixture needle (L) using Carburetor adjustment tool to reach maximum engine speed just before lean drop off.

4. Set idle speed to following speed by turning Throttle adjust screw (T). Engine speed should be stable at following speed +/- 50 r/min after Throttle adjust screw adjustment.

NOTE: Setting for idle maximum speed is as follows depends on type of fuel.

	Mixed two stroke fuel	Premixed alkylate fuel
Idle maximum speed (r/min)	3,700	3,750

5. Turn L mixture needle (L) counterclockwise reducing engine idle speed to set idle speed at following speed.

NOTE: Setting for idle speed is as follows ,depends on type of fuel and condition of carburetor.

NOTE : Engine speed must be allowed to stabilize a minimum of 20 seconds after each adjustment of L mixture needle to assure accurate tachometer readings.

	Mixed two stroke fuel		Premixed alkylate fuel	
	Brand-new carburetor or diaphragm	Used carburetor	Brand-new carburetor or diaphragm	Used carburetor
Idle speed (r/min)	3,300		2,800	

6. Stop engine and install cutter blade.

7. Restart engine and verify engine idle speed ranges. Make sure the cutter does not rotate when engine is idling. When final adjustment is completed, the engine should idle, accelerate smoothly.

	Mixed two stroke fuel		Premixed alkylate fuel	
	Brand-new carburetor or diaphragm	Used carburetor	Brand-new carburetor or diaphragm	Used carburetor
Idle speed range (r/min)	3,100 - 3,400		2,600 - 3,000	

NOTE : Idle engine speed in field operation may vary from final adjustment specifications due to changing ambient conditions and fuel. Engine speed variances should be within the safe ranges for idle engine speed as listed in Section 1-2 Technical data, otherwise the carburetor should be readjusted.

5 CLUTCH SYSTEM AND BELT DRIVING SYSTEM

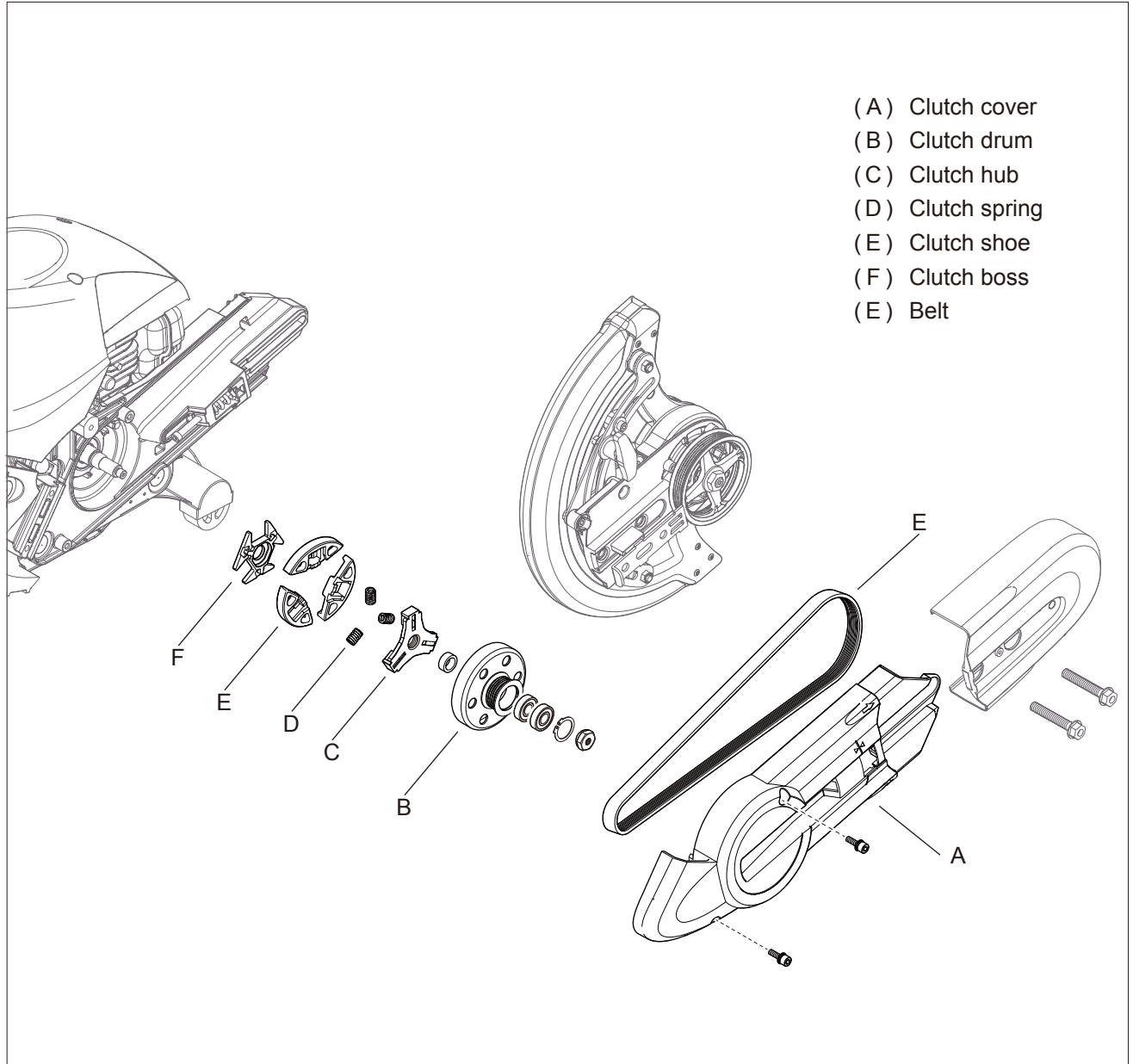

- (A) Clutch cover
- (B) Clutch drum
- (C) Clutch hub
- (D) Clutch spring
- (E) Clutch shoe
- (F) Clutch boss
- (E) Belt

5-1 Adjusting belt tension

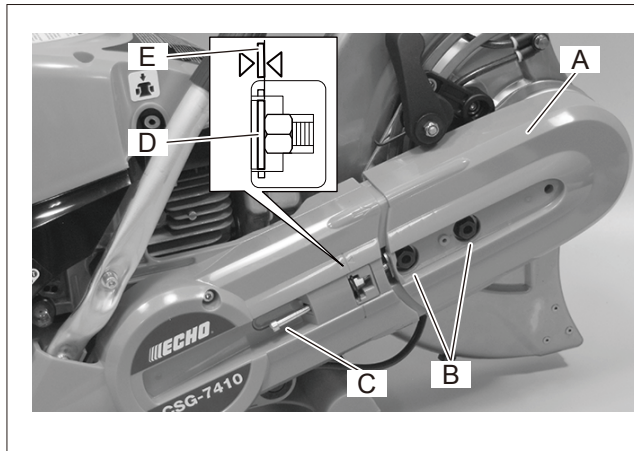

NOTE: Belt tension becomes loose depend on running hours. Make sure to adjust the belt tension when it loosens.

1. Turn 2 bolts (B) counterclockwise about 1 turn with 13 mm socket wrench.
2. Turn bolt (C) until aligning position of washer (D) with mark (E) on clutch cover as shown.
3. Tighten 2 bolts (B).

NOTE: Tightening torque is 23 - 27N•m (230 - 270 kgf•cm) (200 - 235 in•lbf).

5-2 Inspecting and replacing belt

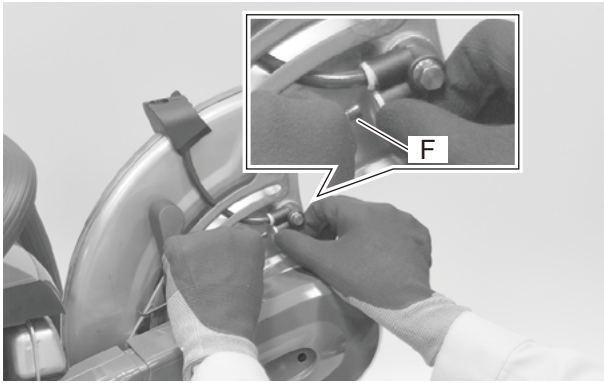

1. Disconnect pipe (F) from pipe connector on cutter cover assembly.

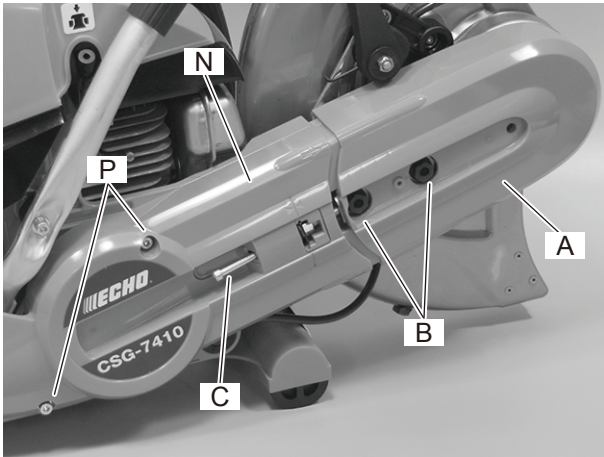

2. Turn bolt (C) counterclockwise to loosen belt tension and then remove 2 bolts (B) and pulley cover (A).

3. Loosen 2 pre-coated bolts (P) and remove clutch cover (N).

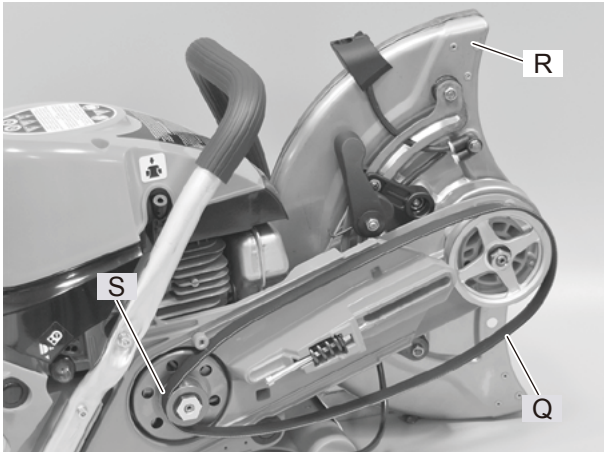

4. Inspect belt (Q) for wearing, peeling, turning, cuts and cracking. Replace with new one as required.

5. Remove belt (Q) and cutter cover assembly (R).

6. Put new belt (Q) on pulley on clutch drum (S).

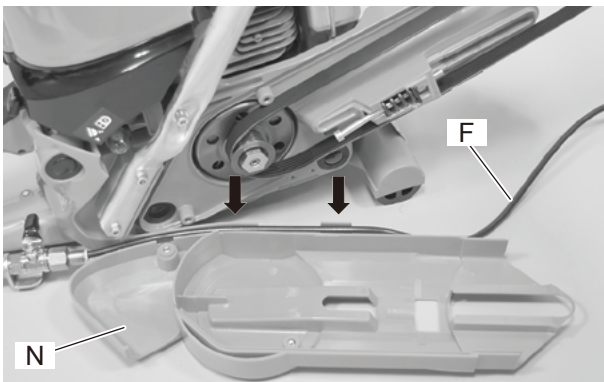

7. Pass pipe (F) through groove on clutch cover (N).

5-2 Inspecting and replacing belt (Continued)

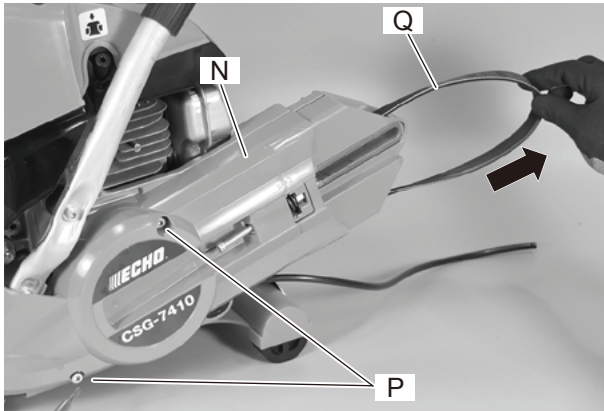

8. Install clutch cover (N) while pulling belt (Q) forward as shown.

9. Tighten 2 pre-coated bolts (P).

NOTE: If the coat is peeled off, replace new one or apply ThreeBond #1344 or equivalent. If old thread locking sealant is left in threads, correct torque may not be secured. In case old thread locking sealant is left, remove it.

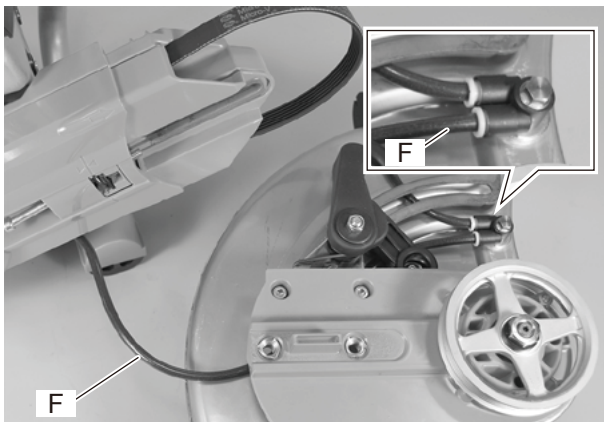

10. Connect pipe (F) to pipe connector on cutter cover assembly as shown.

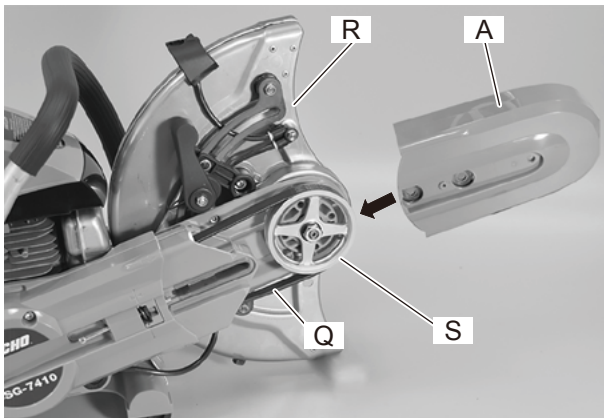

11. Install cutter cover assembly (R) to cutter arm and then hook belt (Q) on pulley (S).

12. Install pulley cover (A) to cutter arm with sliding as shown.

NOTE: Make sure the pulley cover is not misaligned.

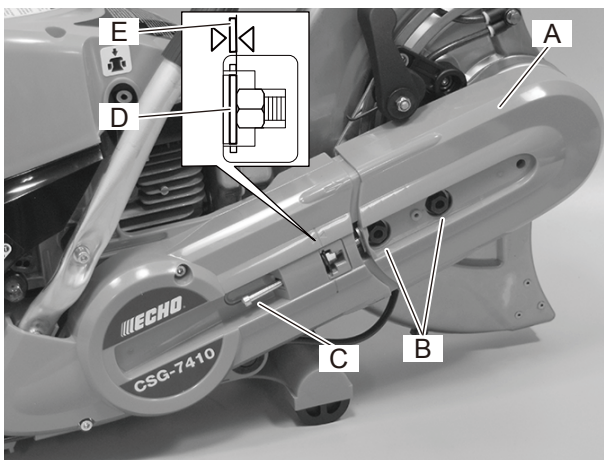

13. Tighten 2 bolts (B) with 13 mm socket wrench and then turn 2 bolts (B) counterclockwise about 1 turn.

14. Turn bolt (C) until aligning position of washer (D) with mark (E) on clutch cover as shown.

15. Tighten 2 bolts (B).

NOTE: Tightening torque is 23 - 27N•m (230 - 270 kgf•cm), (200 - 235 in•lbf).

NOTE: New belt stretches after running. Make sure to readjust belt tension when it becomes loose.

5-3 Inspecting clutch parts

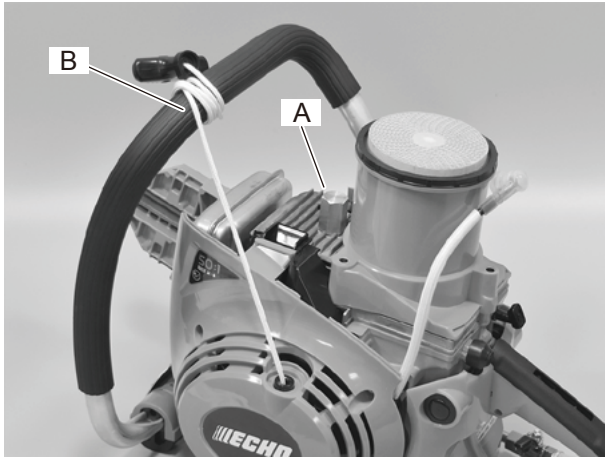

1. Remove pulley cover, clutch cover and cutter cover assembly (Refer to “5-2 Inspecting and replacing belt”).

2. Remove cylinder cover assembly (Refer to “4-1 Replacing air filter”).

3. If starter assembly is installed, remove spark plug and then pull starter rope out, and make a temporary knot (B) to prevent starter damage when installing clutch assembly.

WARNING  **DANGER**

Always remove spark plug cap from spark plug before pulling starter rope for maintenance or repairing. Otherwise, serious personal injury can result. Because ignition switch installed on this unit automatically returns to RUN position, Engine may start unintentionally.

4. Install piston stopper X644-000020 (A) or clean rope into spark plug hole by hand, to stop crankshaft rotation.

5. Loosen nut (C) (Left-hand thread) rotating clockwise with 19 mm socket wrench and remove it.

NOTE: Do not use power tools. Otherwise, piston damage may occur.

6. Remove clutch drum (D) and collar (E) from crankshaft.

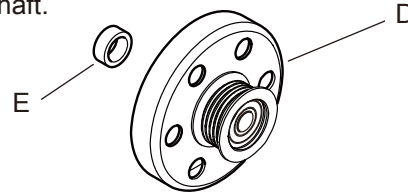

7. Inspect clutch drum (D) for wear and cracks. Inspect ball bearing inside clutch drum for rotating smoothly. Replace as required.

8. Rotate clutch assembly (F) clockwise by hand until it cannot be rotated further.

9. Loosen clutch assembly (F; Left-hand thread) rotating clockwise with Clutch tool X640-000560 (G) and remove it.

10. Inspect clutch hub, clutch shoes and clutch springs for wear, deformation and damage. Replace as required.

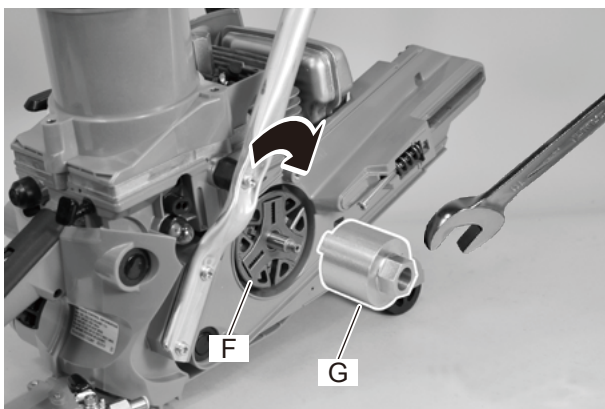
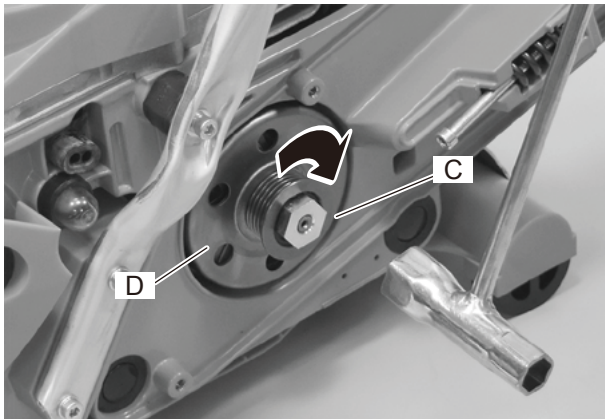

5-4 Installing clutch parts

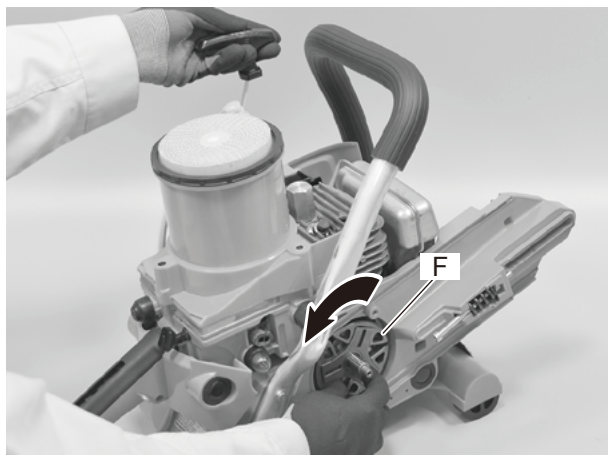

1. Install clutch assembly (F; Left-hand thread) to crankshaft turning counterclockwise by hand until it can not be turned further.

NOTE: If starter assembly is installed, untie temporary knot holding starter grip (tied in the first NOTE of "5-1 Inspecting clutch parts"). While holding starter grip, turn clutch assembly counterclockwise until it cannot rotate further.

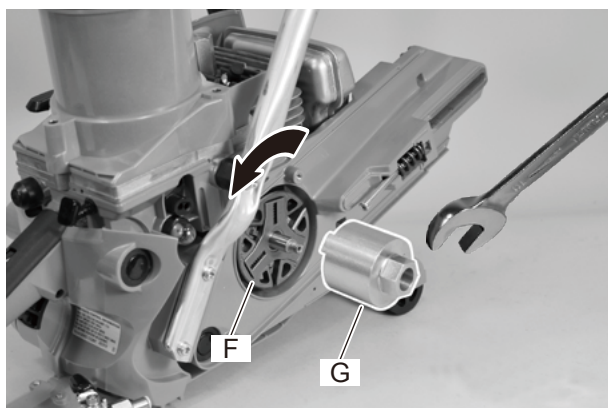

2. Rotate clutch assembly (F) counterclockwise and tighten with Clutch tool X640-000560 (G).

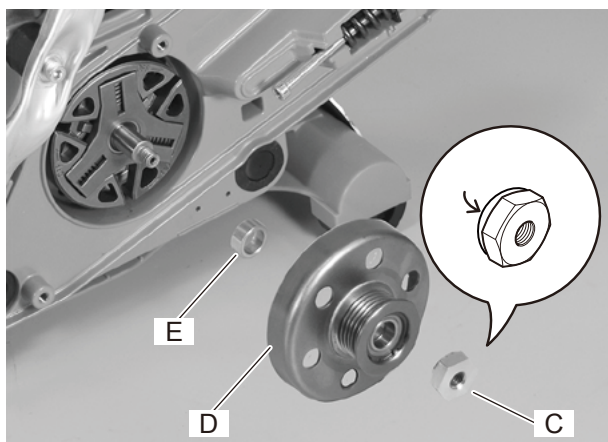

3. Install collar (E), clutch drum (D) to crank shaft and secure them with nut (C).

6 HANDLE AND CONTROL SYSTEM

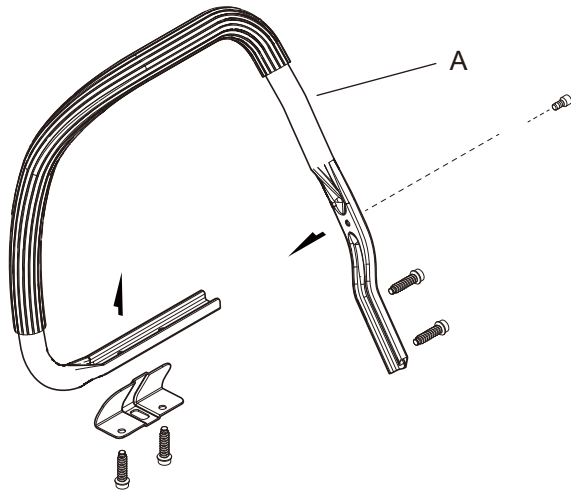

- (A) Front handle
- (B) Rear handle
- (C) Torsion spring
- (D) Throttle trigger
- (E) Throttle lockout
- (F) Rear handle cover
- (G) Cushion (5pcs.)
- (H) Cushion
- (J) Cushion
- (K) Cushion (2pcs.)

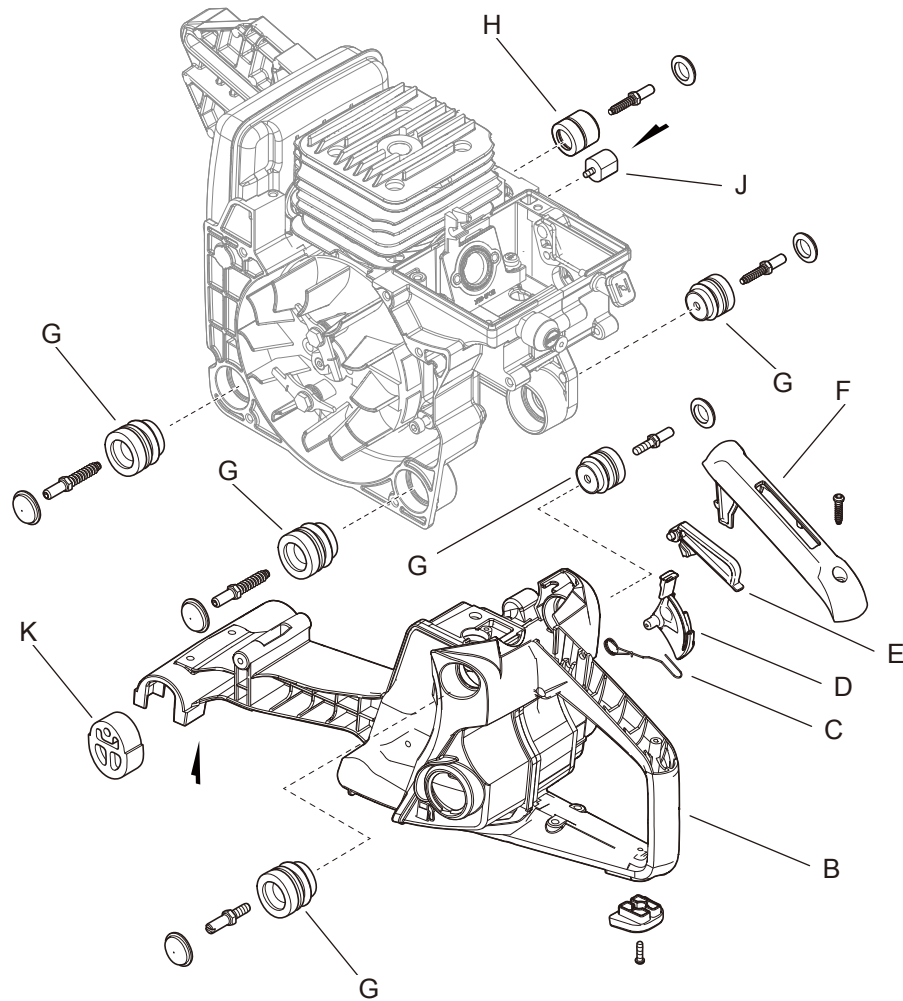

6-1 Replacing cushions and rear handle

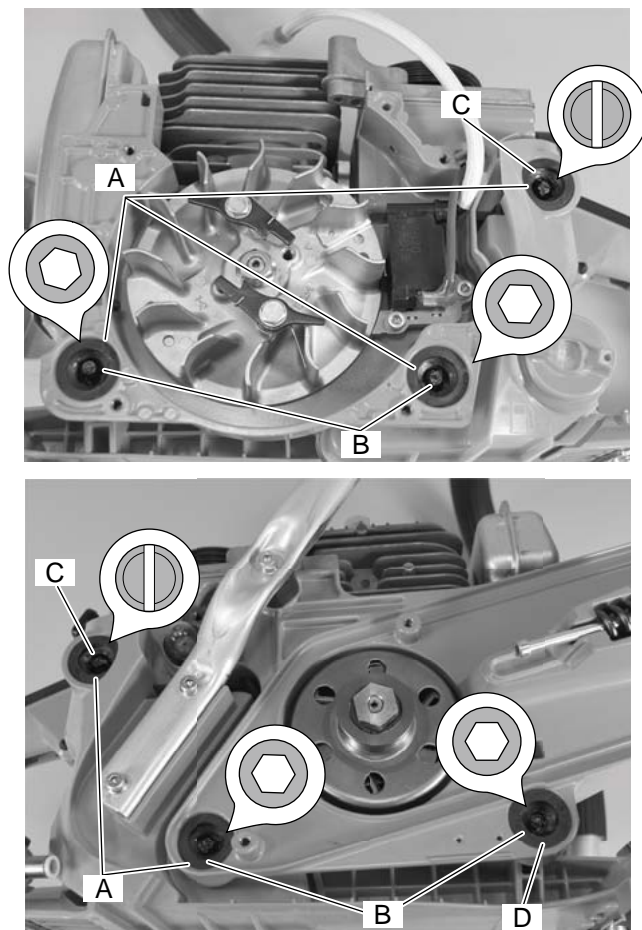

1. Remove starter assembly, carburetor, cutter cover assembly, front handle and throttle system referring to the following section.

Starter assembly; "2-1 Disassembling starter assembly"

Carburetor; "4-5 Removing carburetor, fuel line and tank vent"

Cutter cover assembly; "5-2 Inspecting and replacing belt"

Throttle system; "6-2 Replacing throttle system"

2. Remove 3 cushion caps from cushions (A).

3. Remove 2 hex socket head stopper bolts (B) and slotted head stopper bolt (C).

4. Inspect cushions (A) for wear and cracks. Replace with new one as required.

5. Remove 3 cushion caps from cushions (A) and cushion (D) .

6. Remove 2 hex socket head stopper bolts (B) and slotted head stopper bolt (C).

7. Inspect cushions (A) and cushion (D) for wear and crack. Replace with new one as required.

8. Remove rear handle from crankcase.

9. Install rear handle to crankcase with passing fuel lines through crankcase (Refer to "4-13 Installing carburetor, fuel line and tank vent").

10. Secure rear handle with 4 hex socket head stopper bolts (B) and 2 slotted head stopper bolt (C) referring above disassembling steps.

11. Apply approx. 0.5 g lithium-based grease inside cushions and then install cushion caps to cushions.

6-2 Replacing throttle system

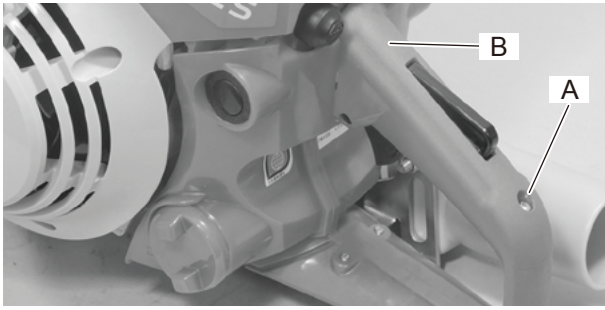

1. Remove bolt (A) and rear handle cover (B).

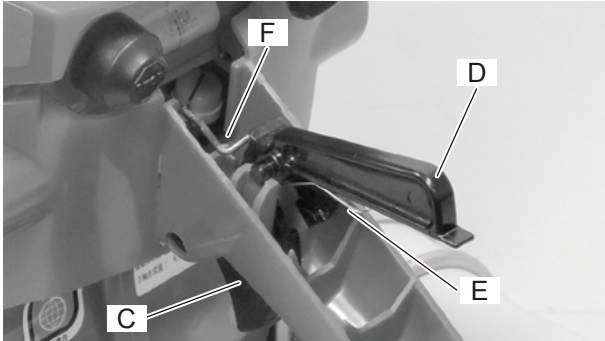

2. Remove throttle lever (C), throttle lockout (D) torsion spring (E) from rear handle. Remove carburetor before removing throttle rod (F) (Refer to "4-5 Removing carburetor, fuel line and tank vent").

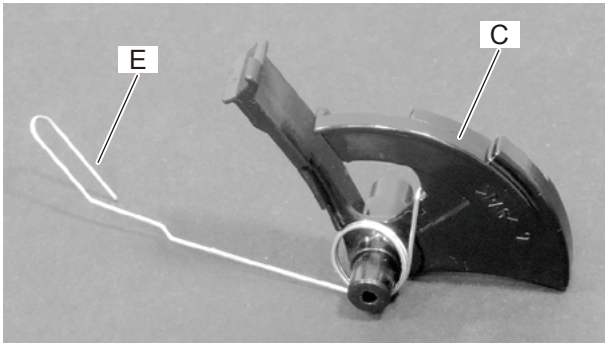

3. Set torsion spring (E) on throttle lever (C) as shown.

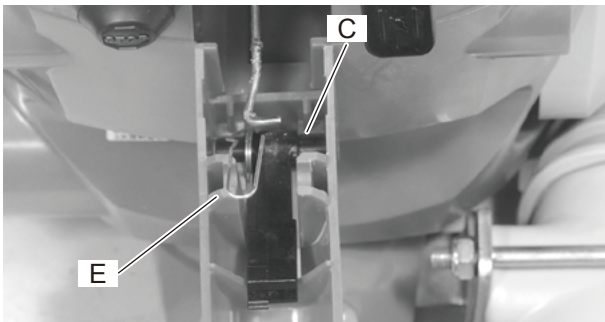

4. Install throttle lever (C) with torsion spring (E) to rear handle as shown.

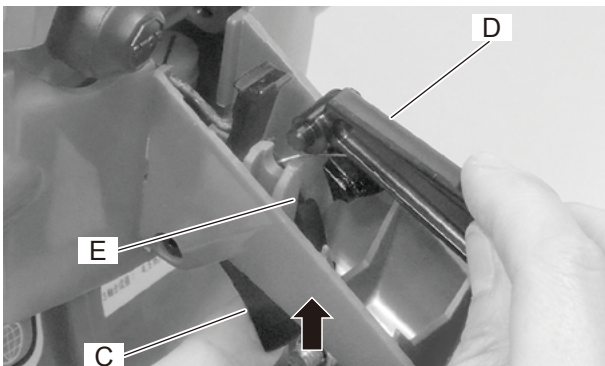

5. Push throttle lever (C) upward and then set throttle lockout on rear handle (D) with hooking torsion spring (E) to throttle lockout (D) as shown.

6. Put rear handle cover (B) on rear handle and secure it with bolt (A).

7 ENGINE

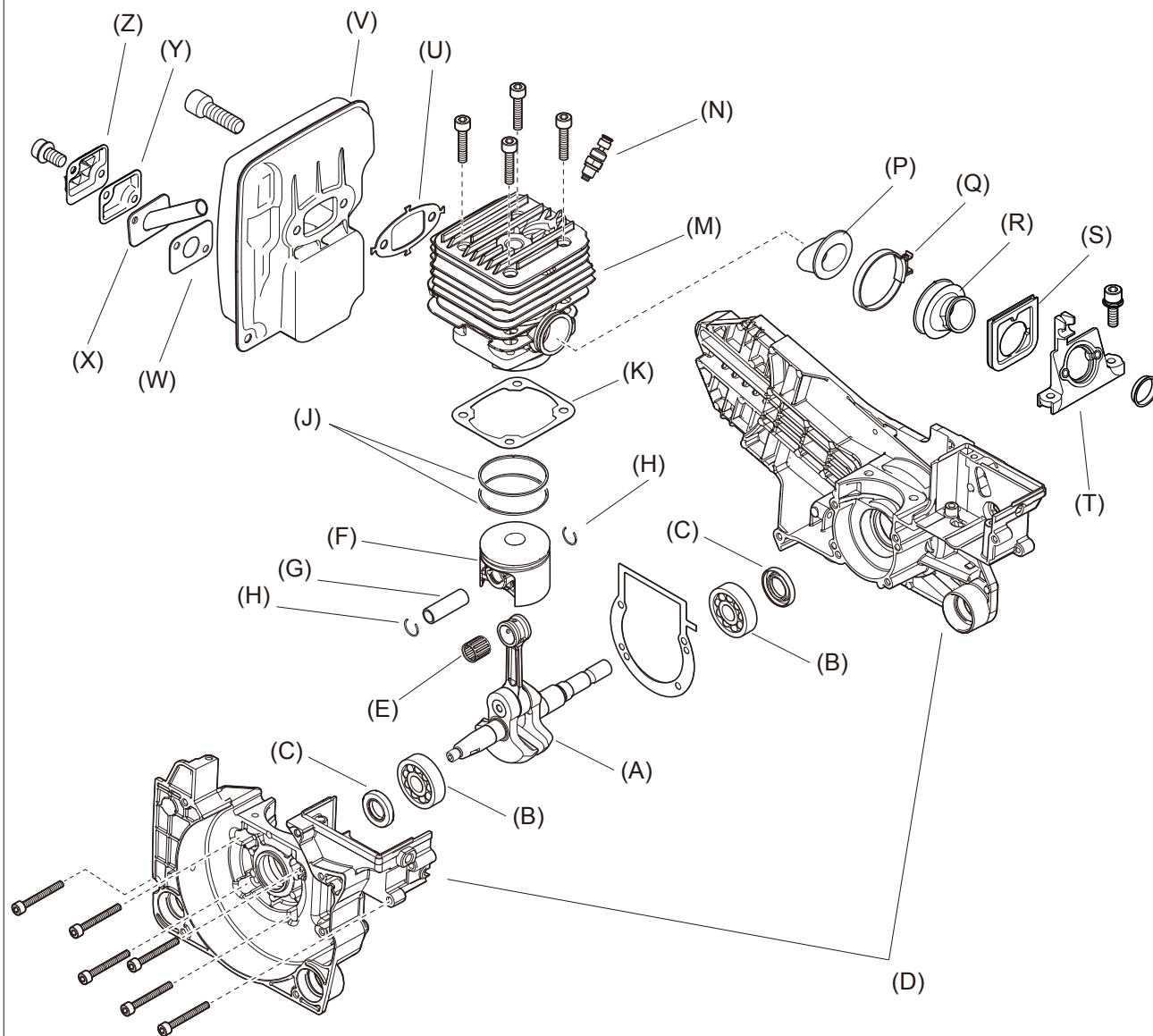

- | | |
|-----------------------------|-----------------------------|
| (A) Crankshaft assembly | (Q) Band |
| (B) Ball bearing (2 pcs.) | (R) Intake bellows |
| (C) Oil seal (2 pcs.) | (S) Seal |
| (D) Crankcase | (T) Intake insulator |
| (E) Needle bearing | (U) Muffler gasket |
| (F) Piston | (V) Muffler |
| (G) Piston pin | (W) Muffler gasket |
| (H) Snap ring (2 pcs.) | (X) Exhaust pipe |
| (J) Piston ring (2 pcs.) | (Y) Spark arrestor screen |
| (K) Cylinder gasket | (Z) Exhaust guide |
| (M) Cylinder | |
| (N) Decompressor | |
| (P) Intake pipe | |

7-1 Cleaning cooling air passages

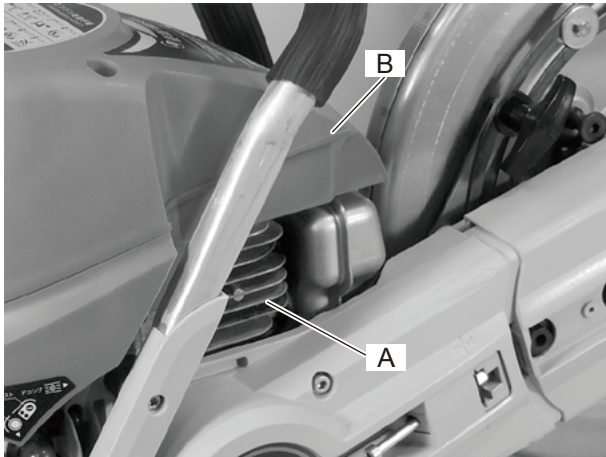

1. Inspect cylinder cooling fins (A) for blockage with dirt. Clean them with wooden or plastic stick or compressed air.

WARNING  **DANGER**

Always wear eye protection when using compressed air for cleaning. Otherwise, eye damage can occur from flying particles.

2. If blockage with dirt is heavy, remove cylinder cover assembly (B) and remove dust.

7-2 Inspecting muffler and exhaust port

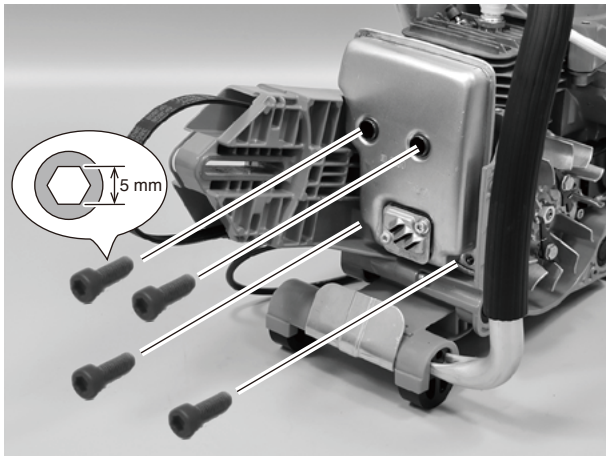

NOTE: Carbon deposits accumulated on exhaust port of cylinder and muffler will cause drop in engine output.

1. Remove pulley cover and cutter cover assembly (Refer to "5-2 Inspecting and replacing belt").
2. Remove cylinder cover assembly (Refer to "4-1 Replacing air filter").
3. Remove spark plug cap from spark plug.

WARNING  **DANGER**

Ignition switch installed this unit automatically returns to RUN position. Engine can start unintentionally. Always remove spark plug cap from spark plug before pulling starter rope for maintenance or repairing, otherwise, serious personal injury can result.

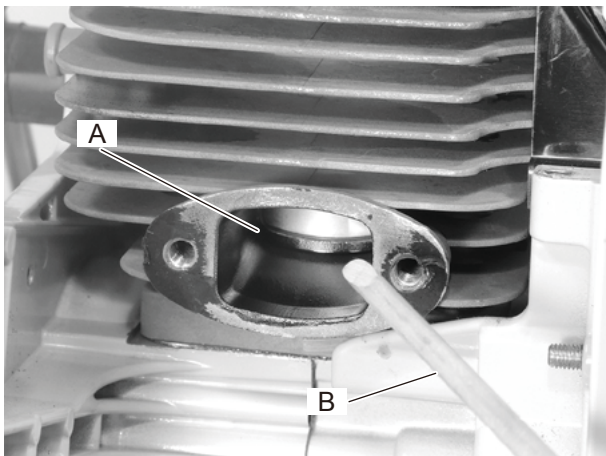

4. Remove 4 bolts and muffler with muffler gasket.
5. Inspect cylinder exhaust port (A) and clean the port using wooden or plastic stick (B) if carbon is found.

NOTE: When cleaning exhaust port, always position piston at Top Dead Center (TDC) to prevent carbon from entering cylinder. Do not use metal tool, and be careful not to scratch piston or cylinder.

7-2 Inspecting muffler and exhaust port (Continued)

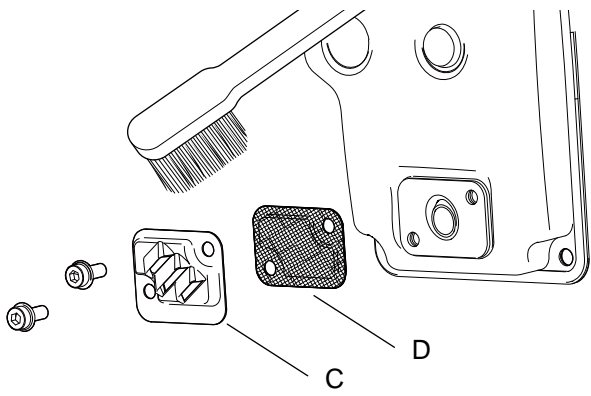

6. Remove exhaust guide (C) and spark arrestor screen (D) from muffler.
7. Remove carbon deposits from spark arrestor screen (D) and exhaust guide (C). If the screen and the guide have heavy deposits, replace with new one(s).
8. Reinstall spark arrestor screen (D) and exhaust guide (C) to muffler.
9. Reinstall muffler with new muffler gasket.

7-3 Testing cylinder compression

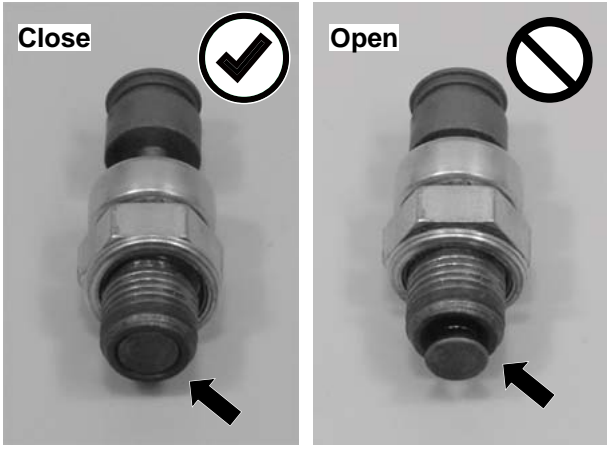

NOTE: Test cylinder compression when engine is cold.

1. Remove cylinder cover assembly (Refer to “4-1 Replacing air filter”).
2. Remove decompressor from cylinder. Confirm valve on decompressor is closed. If not, push the valve to close it.

NOTE; When carbon deposits are accumulated around valve of decompressor, remove the deposits or replace with new one as required. (Refer to “7-5 Inspecting decompressor”).

3. Reinstall decompressor.
4. Remove spark plug and install Compression gauge 91037 (A) in spark plug hole and tighten by hand. Pull starter several times to stabilize reading on compression gauge.
5. If pressure is lower than approx. 75% of standard compression pressure (Refer to “1-2 Technical data ”), inspect cylinder bore, piston, and piston ring for wear or damage.
6. If pressure is more than approx. 125% of standard compression pressure, inspect cylinder combustion chamber, exhaust port and piston crown for carbon deposits.

NOTE: Compression pressure varies with volume of compression gauge tip occupying cylinder combustion chamber. If gauge tip volume is considerably different from spark plug volume, it is recommended to measure and note compression pressure of brand-new engines as standard pressure in advance.

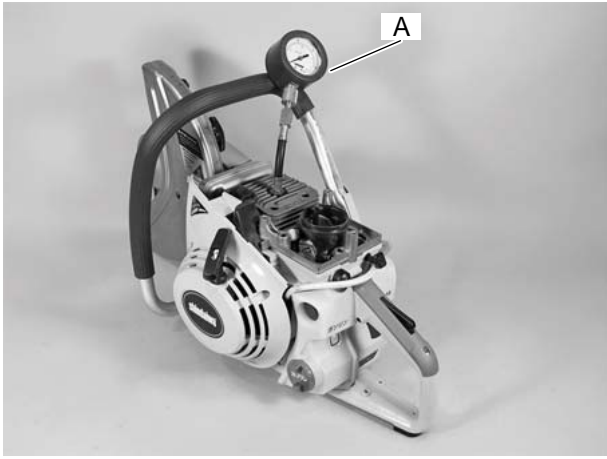

7-4 Testing crankcase and cylinder seal

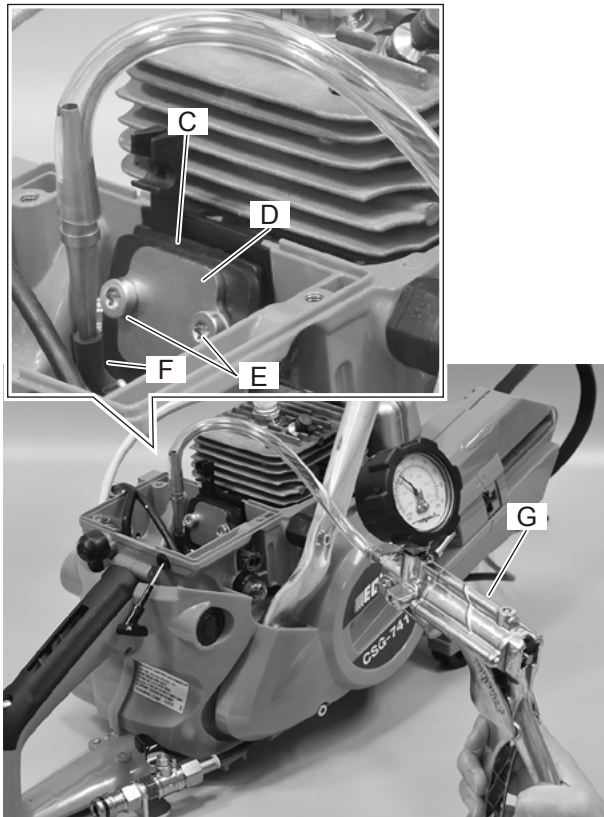
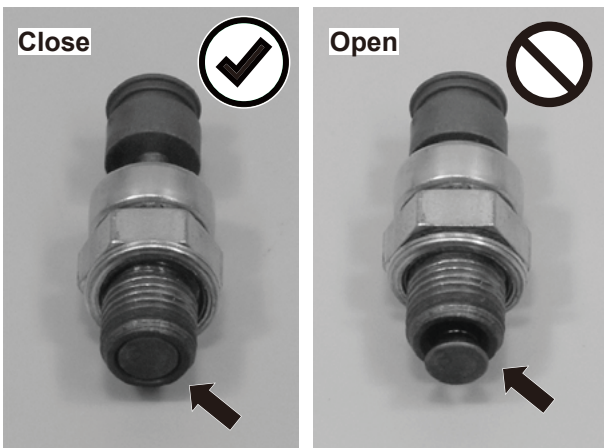
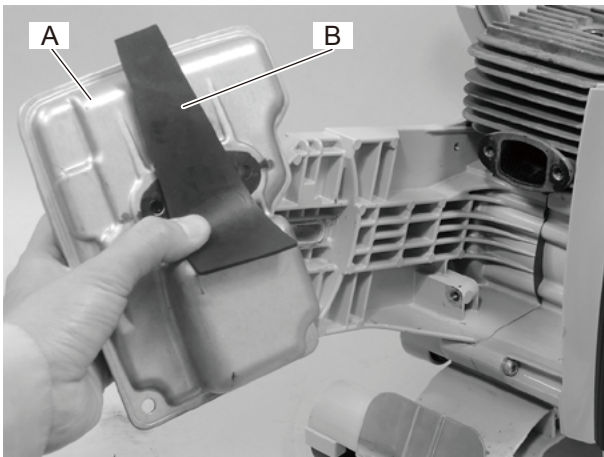

1. Remove muffler.
2. Set Pressure rubber plug 91041 (D) on muffler to cover exhaust port as shown.
3. Reinstall muffler with Pressure rubber plug 91041 (D) on cylinder to seal exhaust port. Secure them with 4 muffler bolts.

3. Remove decompressor from cylinder. Confirm valve on decompressor is closed. If not, push the valve to close it.

NOTE; When carbon deposits are accumulated around valve of decompressor, remove the deposits or replace with new one as required. (Refer to "7-5 Inspecting decompressor").

4. Reinstall decompressor.

5. Remove carburetor (Refer to "4-5 Removing carburetor, fuel line and tank").

6. To seal intake port, set Pressure rubber plug 897826-16131 (C) and Pressure plate 897827-16131 (D) on intake port. Tighten them with M5 bolts (E) of 10 - 15 mm (0.4 - 0.6 in) length.

7. Connect pulse line (F) and Pressure / vacuum tester 91149 (G) with suitable joint.

8. Apply negative pressure approx. 0.03 MPa (0.3 kgf/cm²) (4.3 psi) by the tester (J) and leave for 30 seconds.

9. If the pressure decreases, leakage may occur from oil seal. Inspect oil seal for damage or wear.

10. Apply pressure approx. 0.05 MPa (0.5 kgf/cm²) (7 psi) by the tester (G) and leave for 30 seconds.

11. If the pressure drops, leakage may occur.

12. Leakage may occur from crankcase seam, cylinder base, oil seal or decompressor. Use soapy water to locate leakage.

7-5 Inspecting decompressor

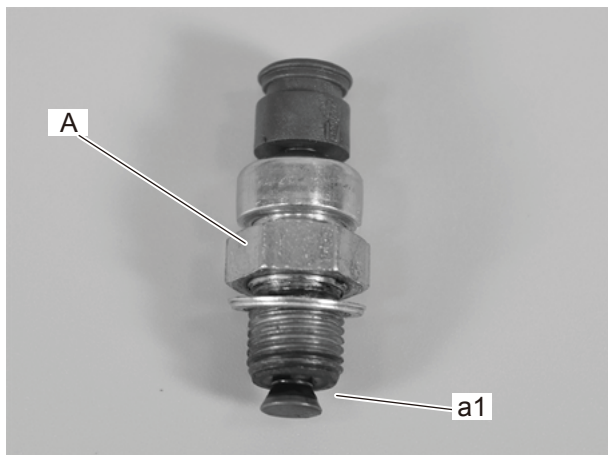

NOTE: When the area around decompressor (A) is extremely dirty, leakage of exhaust gas can be occurred due to carbon deposits around valve (a1) of decompressor (A). Inspect as follows.

1. Remove decompressor (A) from cylinder with 13mm socket wrench.
2. Inspect decompressor (A) for carbon deposits around the valve (a1) and remove the deposits or replace with new one as required.

NOTE: Do not disassemble decompressor.

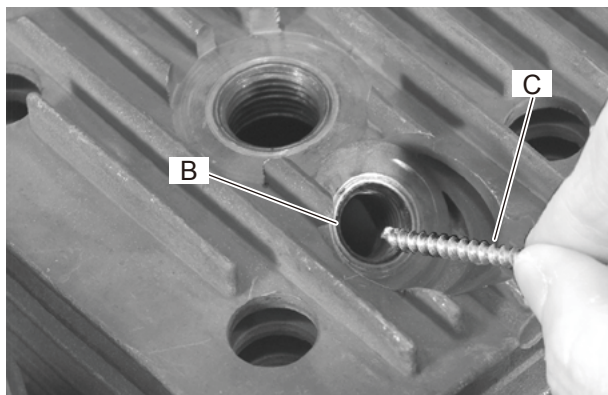

3. Inspect decompressor hole (B) for accumulating carbon deposits. Remove the deposits with screw or suitable tool after removing cylinder from the unit.

7-6 Inspecting cylinder and intake parts

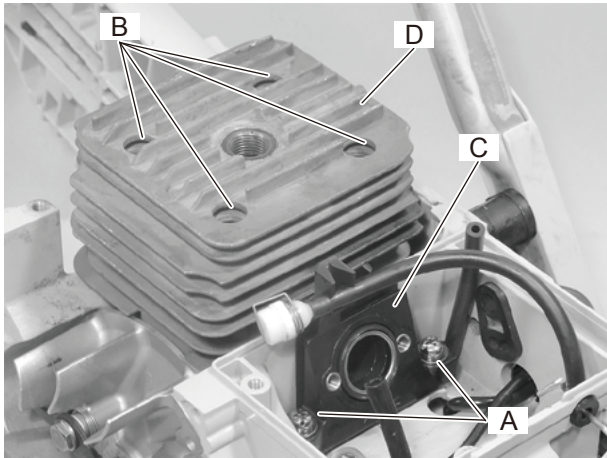
**Removing cylinder**

1. Remove starter assembly, carburetor, cutter cover assembly and muffler referring to the following section.

Starter assembly; "2-1 Disassembling starter assembly"

Carburetor; "4-5 Removing carburetor, fuel line and tank vent"

Cutter cover assembly; "5-2 Inspecting and replacing belt"

2. Remove 2 bolts (A) from intake insulator

3. Remove 4 bolts from cylinder base through holes (B).

4. Remove cylinder (D) with intake insulator (C).

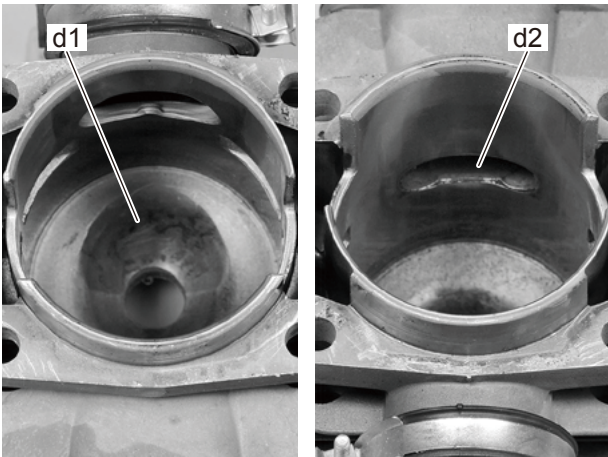
**Inspecting cylinder**

1. Inspect cylinder combustion chamber (d1) and exhaust port (d2). Clean with a plastic or wooden scraper if carbon is found.

NOTE: Do not use metal tools, or damage to cylinder wall may result.

2. Inspect cylinder wall. If plating is worn, peeled away, scored or exposing cylinder base metal, replace with a new one (Refer to "7-10 Installing piston and cylinder").

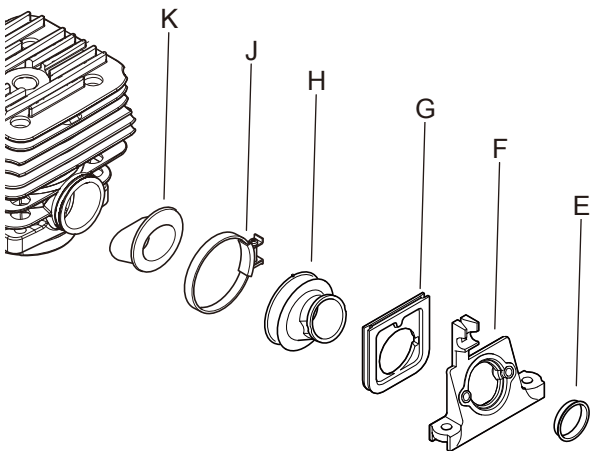
**Inspecting intake parts**

1. Remove sleeve (E), intake insulator (F), seal (G), intake bellows (H), band (J) and intake pipe (K) from cylinder.

2. Inspect removed parts for wear, cuts and cracks. Replace with new one(s) as required (Refer to "7-10 Installing piston and cylinder").

7-7 Inspecting piston and piston ring

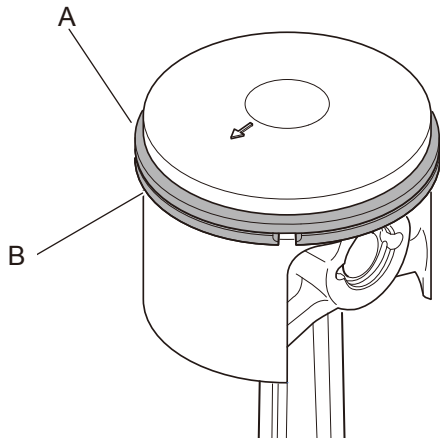

1. Inspect piston ring (A) and (B). If broken or scored, or if it exceeds service limits (Refer to "1-5"), replace with new one(s) (Refer to "7-10 Installing piston and cylinder").

2. When removing piston rings, remove top ring (A) at first and then remove second ring (B).

3. Inspect piston crown, top land, ring groove and skirt. If carbon is found, remove piston and then clean it as follows.

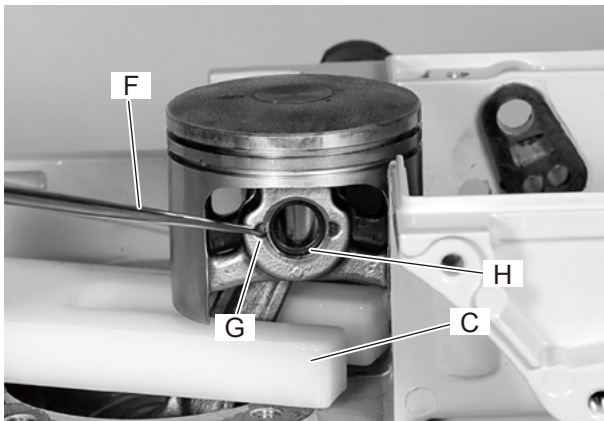

4. Insert awl (F) or suitable pointed tool into concave area (G) of piston pin hole and remove snap ring (H) from both sides of piston pin.

NOTE: Piston holder 897719-02830 (C) is recommended.

NOTE: Do not reuse removed snap rings. Make sure to replace with new ones.



5. Push piston pin out from piston.

NOTE: If piston pin is tight, use Piston pin tool X640-000090 with adapter (J) stamped "757".

6. Inspect needle bearing (L) and piston pin (K), and replace if wear or discoloration is noted (Refer to "7-10 Installing piston and cylinder").

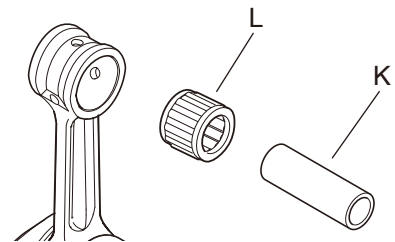

7. Clean piston crown with fine sand paper, oil stone, or soft cleaning brush (D).

8. Clean piston top land, ring groove and skirt with soft cleaning brush (D).

NOTE: Do not use square end of broken piston ring when cleaning piston ring groove, otherwise piston ring groove might be damaged.

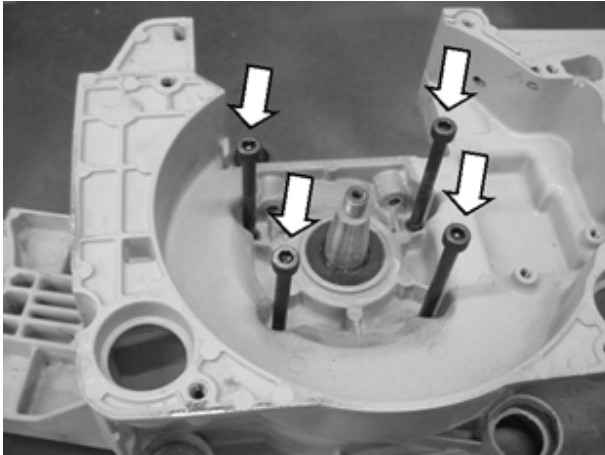

7-8 Disassembling crankcase

**Separating crankcase**

1. Referring to "9-1 Disassembly chart", remove necessary parts for crankcase disassembly.
2. Remove woodruff key from crankshaft magneto rotor end.
3. Remove 6 bolts from crankcase.
4. Screw long 4 bolts (length: approx. 75 - 80 mm) on one side of crankcase halves (in the picture, magneto side is shown).
5. Hold crankcase and alternately tap 4 bolts using plastic mallet to separate crankcase halves.
6. Clean and inspect crankshaft and crankcase for damage and discoloration.
7. Check ball bearing for smooth rotation. If rough, replace it (them) with new one(s) as follows.

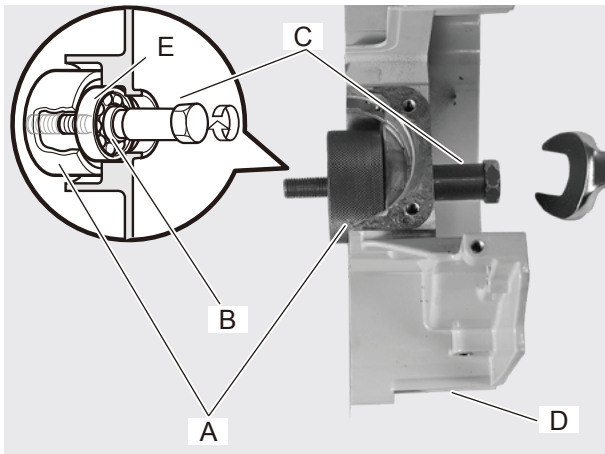
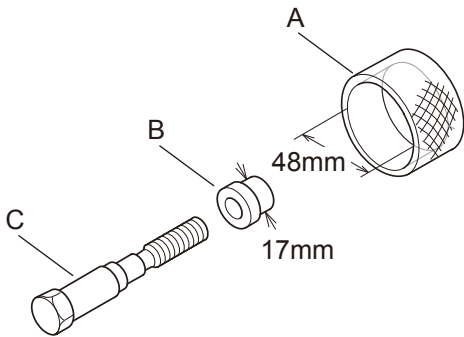
**Removing ball bearing**

1. When removing ball bearing on this unit, use Boss (A), Adapter (B) and Shaft (C) in Bearing tool 897701-14732.
2. When removing ball bearing (E) from magneto side crankcase half, set Shaft (C) and Adapter (B) through oil seal and ball bearing (E) with Boss (A) as shown.
3. Tighten Shaft (C) with 19 mm wrench to remove ball bearing (E) and oil seal.
4. When removing ball bearing (E) from clutch side crankcase half, set Shaft (C) through oil seal and ball bearing (E) with Boss (A) as shown.
5. Tighten Shaft (C) with 19 mm wrench to remove ball bearing (E) and oil seal.

7-9 Assembling crankcase

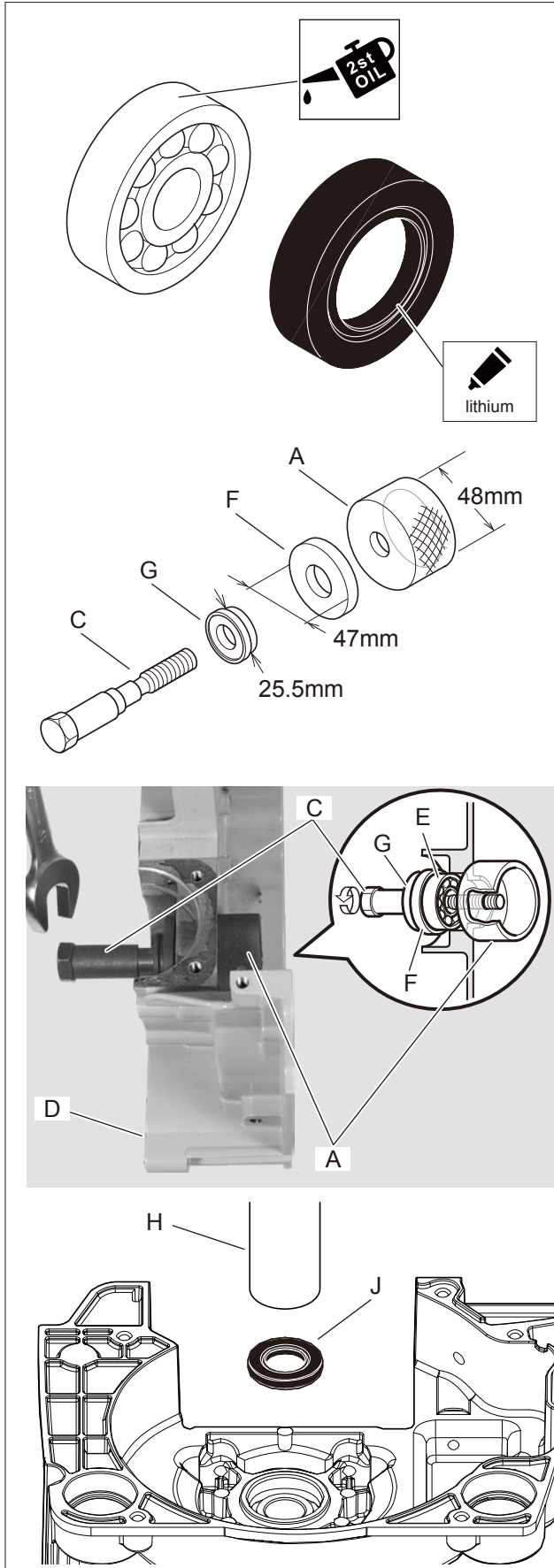

Preparation for assembling

1. Apply lithium based grease on inner rubber lips of new oil seal.
2. Lubricate circumferences of ball bearing with 2 stroke oil.

Inserting ball bearing and oil seal

NOTE: There are 2 ways to insert ball bearing and oil seal as follows, depending on service tools.

1) Using Bearing tool 897701-14732 and Oil seal tool 897726-21430

1. Use Boss (A), Adapter (F), Adapter (G) and Shaft (C) in Bearing tool 897701-14732.

2. Set ball bearing (E) with Boss (A), Adapter (F), Adapter (G) and Shaft (C) as shown.
3. Tighten Shaft (C) with 19 mm wrench to press ball bearing into the crankcase half until flush.
4. Check that bearing rotates smoothly.

5. Push new oil seal (J) by maximum 1.0 mm (0.04 in) deep using Oil seal tool 897726-21430 (H).

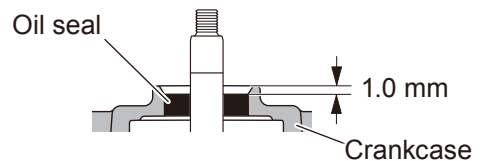

7-9 Assembling crankcase (Continued)

2) Using Holder 22169-96410, X643-000020, Rod oil seal 22182-96460, X646-000060, Rod bearing X646-000050 and X646-000081

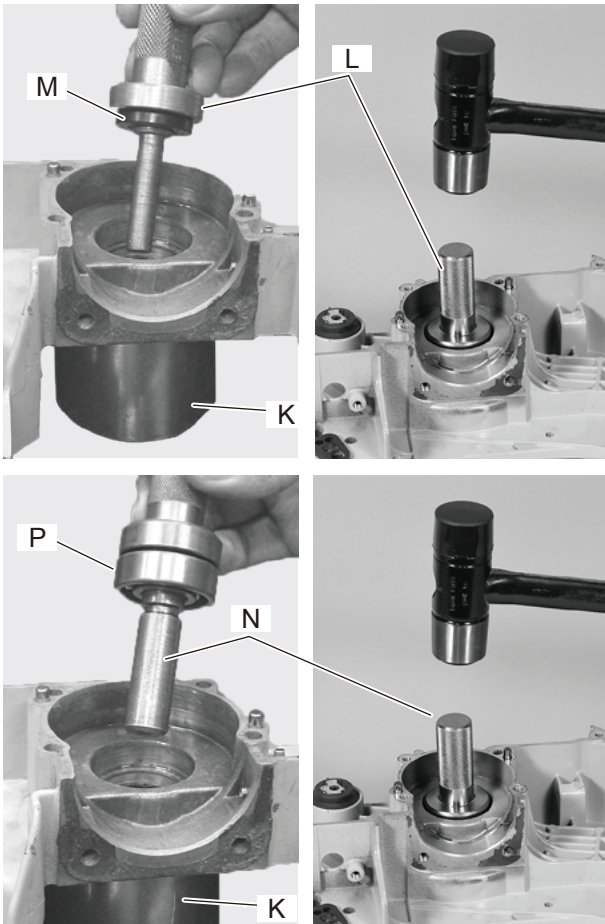
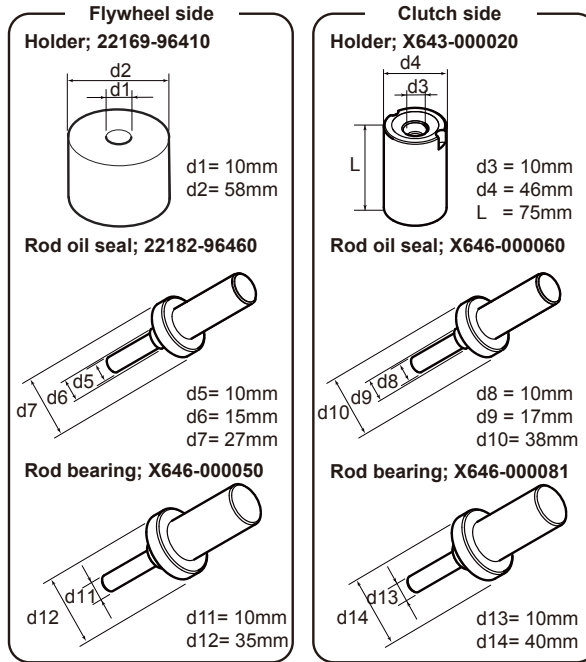

1. Set clutch side crankcase half on Holder X643-000020 (K) as shown.

2. Set new oil seal (M) with Rod oil seal X646-000060 (L) on crankcase boss as shown.

3. Tap Rod oil seal (L) using mallet or push the rod (L) to put oil seal in.

4. Set ball bearing (P) with Rod bearing X646-000081 (N) on crankcase boss as shown.

5. Tap Rod bearing (N) using mallet or press the rod (N) to put ball bearing in.

6. Insert magneto side oil seal and ball bearing using Holder 22169-96410, Rod oil seal 22182-96460, and Rod bearing X646-000050 same as above steps.

7-9 Assembling crankcase (Continued)

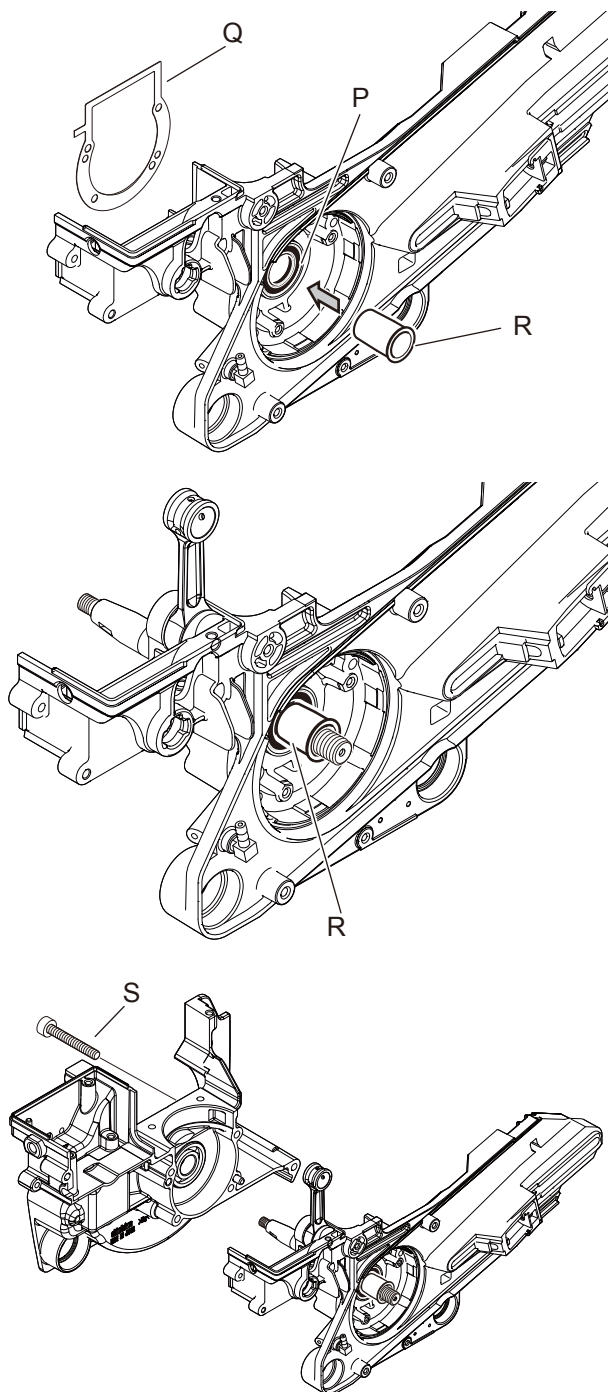

Assembling crankshaft and crankcase

1. Clean mating surface of each crankcase half.
2. Heat ball bearing for easier installation.

WARNING  **DANGER**

When using a heat gun, wear gloves. Otherwise, a burn will result.

3. Put new crankcase gasket (Q) on clutch side crankcase half.

4. Insert collar oil seal tool X646-000590 (R) into oil seal (P) of the clutch side.

NOTE: Use collar oil seal tool X646-000590 (R) to prevent oil seal lip from rolling up when inserting crankshaft.

5. Insert crankshaft clutch side end into collar oil seal tool (R).

6. Insert crankshaft magneto side end into magneto side crankcase half.

7. Temporarily tighten 6 pre-coated bolts (S) diagonally to loosely assemble crankcase halves.

NOTE: If the bolts (S) is not long enough, prepare longer bolts and tighten with them to get crankcase halves closer. Then replace longer bolts with pre-coated bolts for securing crankcase.

NOTE: If the coat is peeled off, replace new one or apply ThreeBond #1344 or equivalent. If old thread locking sealant is left in threads, correct torque may not be secured. In case old thread locking sealant is left, remove it.

7-9 Assembling crankcase (Continued)

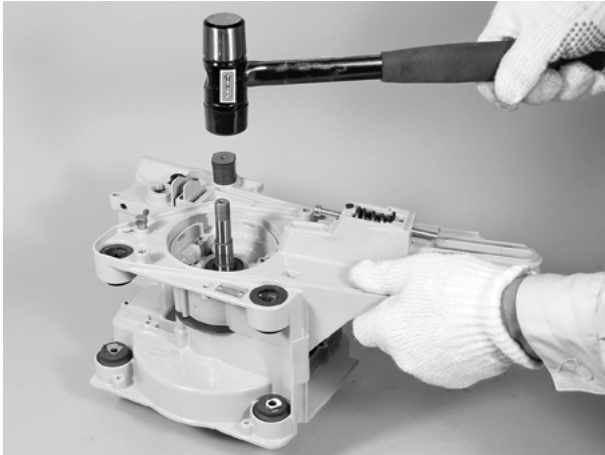

8. Tap both ends of crankshaft with plastic mallet several times for crankshaft smooth rotation.

9. Tighten 6 bolts to secure crankcase halves together and recheck crankshaft for smooth rotation.

NOTE: If crankshaft does not rotate smoothly, loose 6 bolts and tap both ends of crankshaft with plastic mallet several times. Then retighten the bolts to secure crankcase.

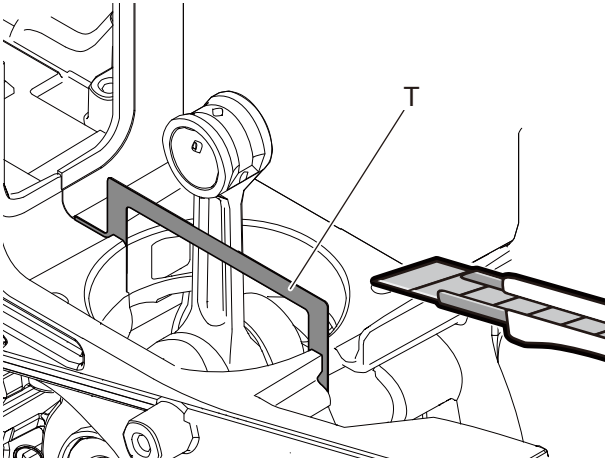

10. Carefully remove excess portion (T) of crankcase gasket with sharp knife.

7-10 Installing piston and cylinder

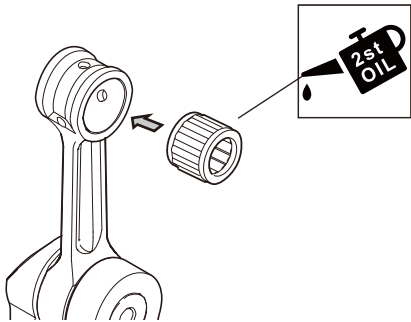
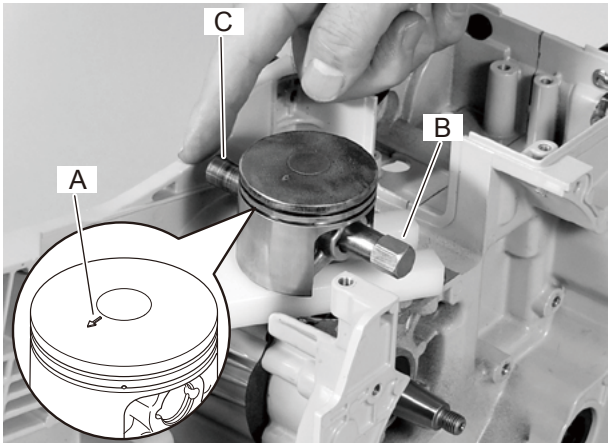
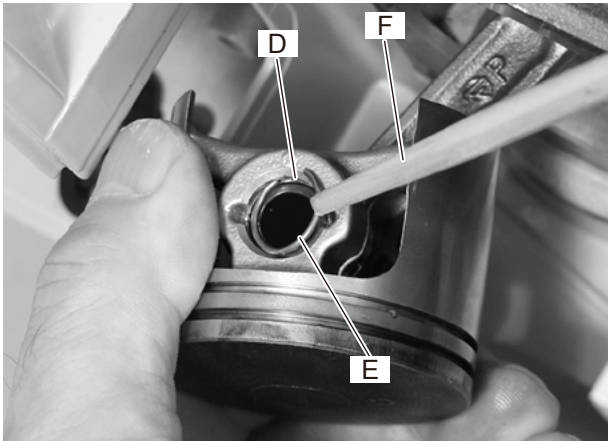
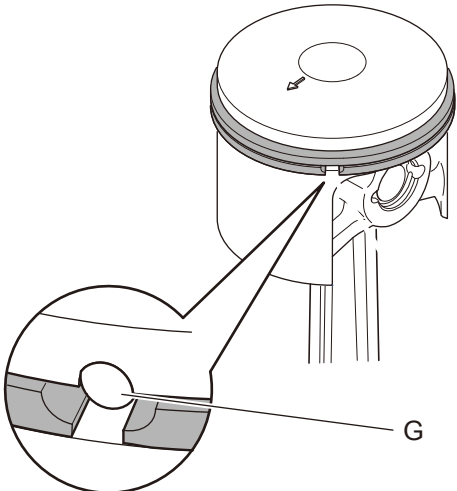
Installing piston and piston rings

- Lubricate needle bearing with 2-stroke oil and then insert the needle bearing into small end of connecting rod.
- Place piston over the small end of connecting rod, so that the arrow mark (A) on piston points front (muffler side) as shown.
- Insert Piston pin guide (B) stamped "757", through piston and needle bearing in connecting rod as shown.

NOTE: Piston pin guide (B) is included in Piston pin tool X640-000090.

- Insert piston pin (C) in piston pushing out piston pin guide (B).
- Install new snap rings (E) to piston using small flat head screwdriver or appropriated tool (F) and make sure that they are correctly seated in the grooves (D).
- Install piston rings on piston, ensuring the end gaps of piston ring are properly around locating pin (G) as shown.

7-10 Installing piston and cylinder (Continued)

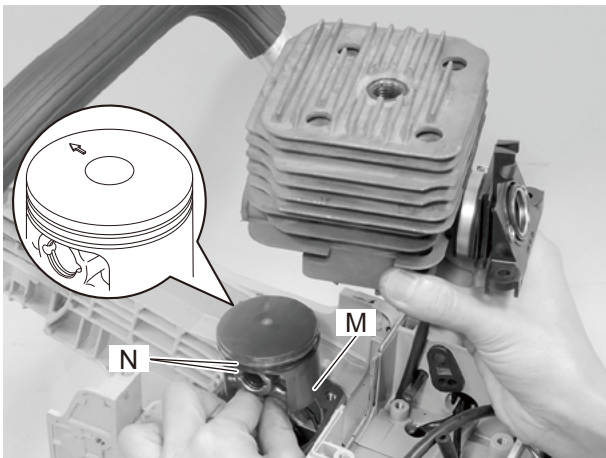
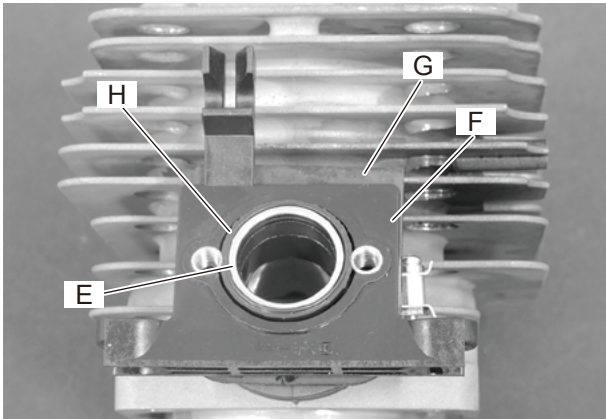
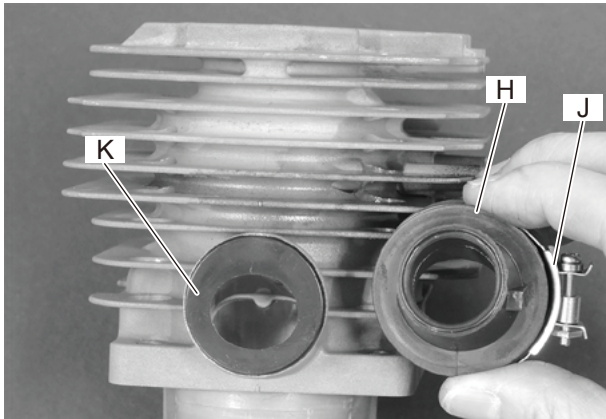
**Installing intake parts and cylinder**

1. Insert intake pipe (K) into intake port of cylinder.
2. Place band (J) on intake bellows (H) as shown.
3. Place intake bellows (H) with band (J) on intake port of cylinder to align mark (d3) on cylinder and mark (h1) on intake bellows.

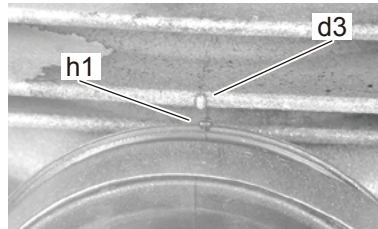

4. Secure intake bellows (H) with tightening band (J).
5. Install seal (G) and intake insulator (F) on intake bellows (H).
6. Insert sleeve (E) into intake bellows (H).

7. Set new cylinder gasket on crankcase.

NOTE: Completely remove old gasket residue on mating surfaces of cylinder and crankcase before setting new gasket.

8. Apply 2-stroke oil to piston rings (N) and internal wall of cylinder.

9. Install piston in cylinder with arrow pointing as shown.

NOTE: When installing cylinder, it is convenient to use Piston holder 897719-02830 to stabilize piston.

NOTE: When installing piston in cylinder, do not twist cylinder to avoid breakage of piston rings and scoring cylinder bore.

10. Secure cylinder with 4 pre-coated bolts.

NOTE: If the coat is peeled off, replace new one or apply ThreeBond #1344 or equivalent. If old thread locking sealant is left in threads, correct torque may not be secured. In case old thread locking sealant is left, remove it.

8 CUTTING SYSTEM

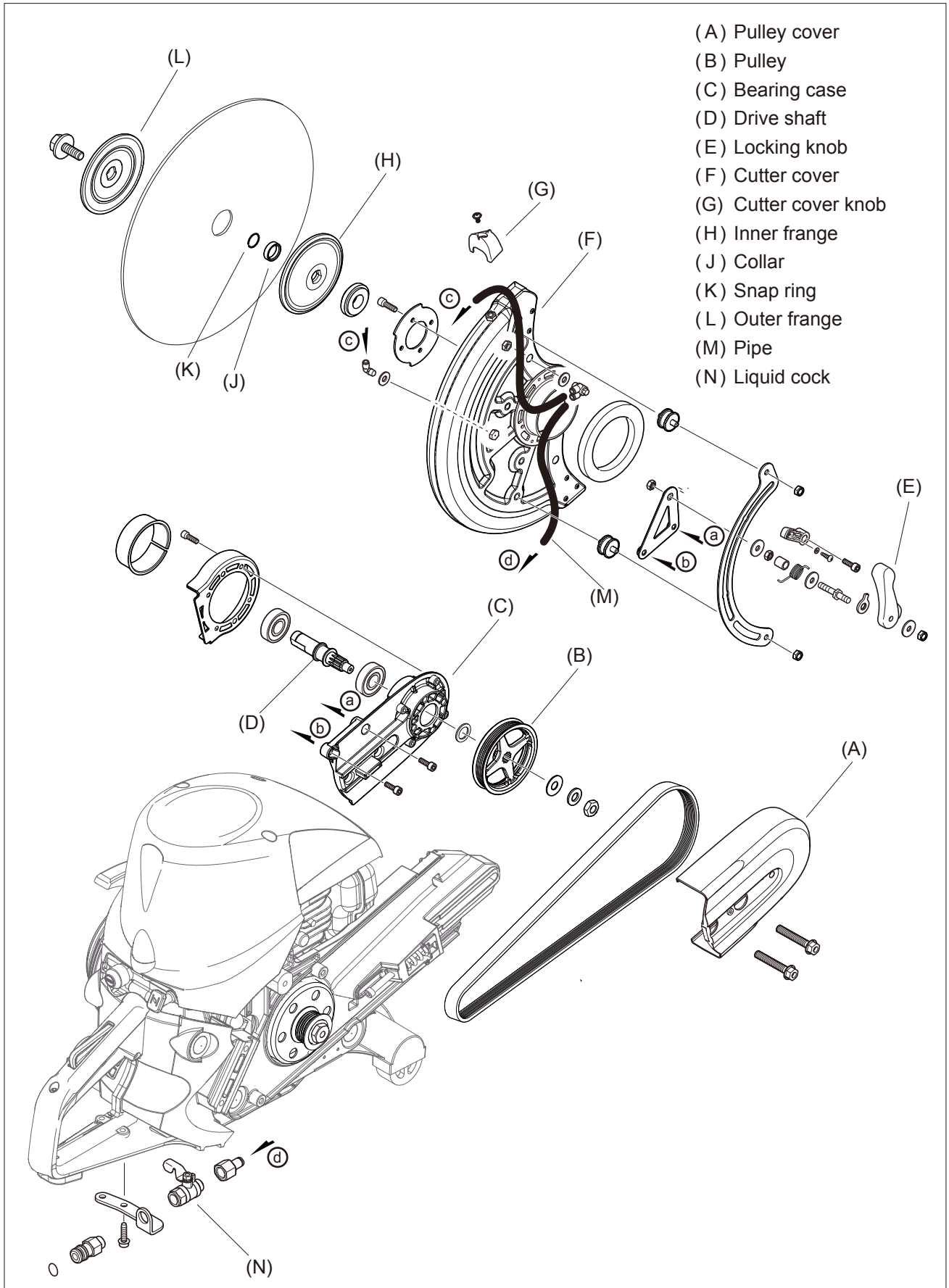

- (A) Pulley cover
- (B) Pulley
- (C) Bearing case
- (D) Drive shaft
- (E) Locking knob
- (F) Cutter cover
- (G) Cutter cover knob
- (H) Inner frange
- (J) Collar
- (K) Snap ring
- (L) Outer frange
- (M) Pipe
- (N) Liquid cock

8-1 Disassembling cutter cover assembly

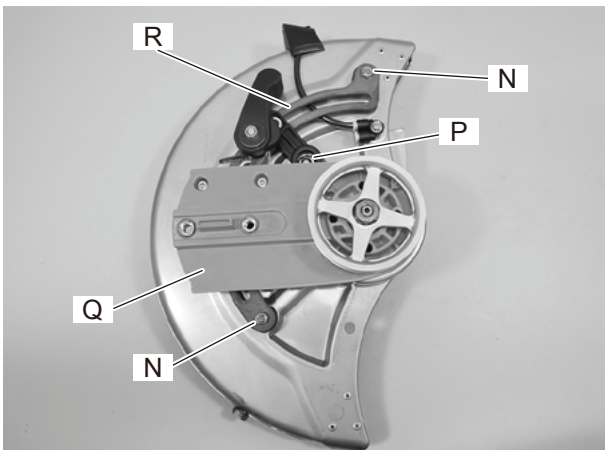
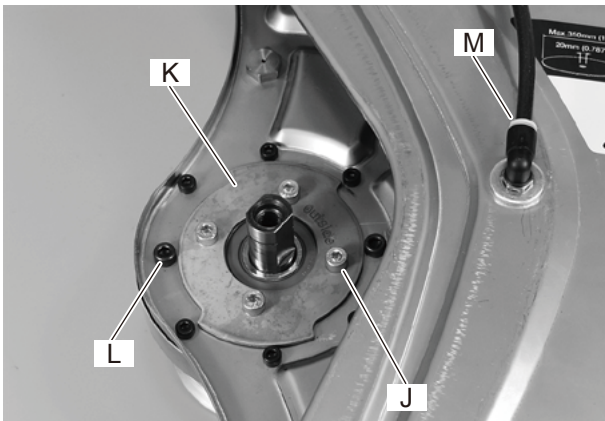
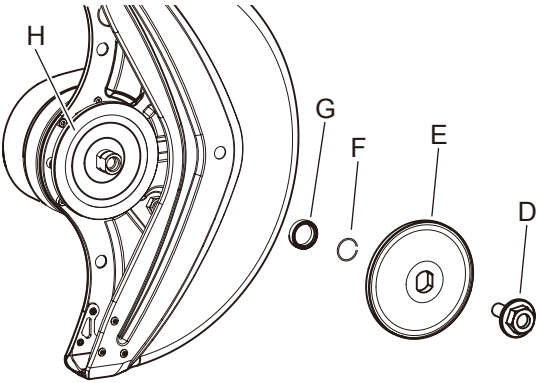
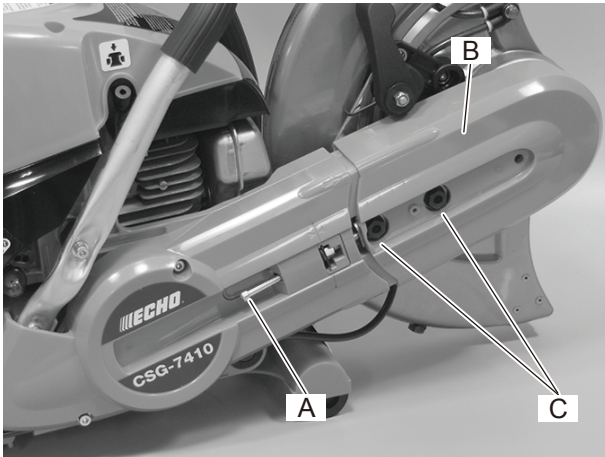

1. Loosen tension screw (A).
2. Remove 2 bolts (C) with 13mm socket wrench and slide pulley cover (B) forward to remove it.
3. Remove cutter cover assembly from unit.

4. Remove bolt (D) with 19 mm socket wrench and then remove outer frange (E).

5. Remove snap ring (F) using small flat head screw and then remove collar (G) and inner frange (H).

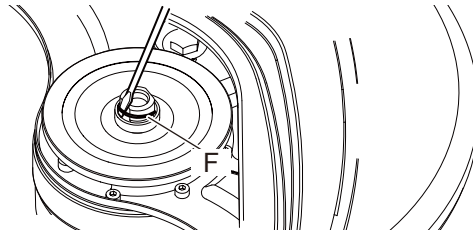

6. Remove 4 pre-coated bolts (J) and cutter cover plate (K).

NOTE: 8 bolts (L) do not have to be removed.

7. Disconnect pipe (M) from pipe connector on cutter cover assembly.

8. Remove 2 nuts (N) and bolt (P).

9. Remove bearing case (Q) with slide plate (R) from cutter cover assembly.

8-1 Disassembling cutter cover assembly (Continued)

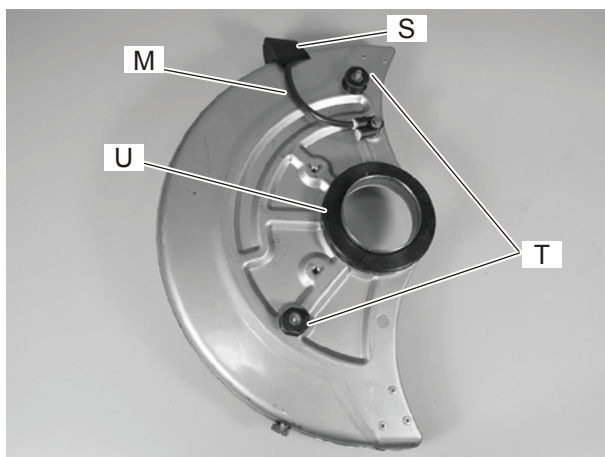

10. Remove cutter cover knob (S).
11. Disconnect pipe (M) from pipe connector on cutter cover assembly.
12. Remove 2 cushions (T) from cutter cover assembly.
13. Remove ring (U) from cutter cover assembly.

8-2 Replacing pulley, drive shaft and ball bearing

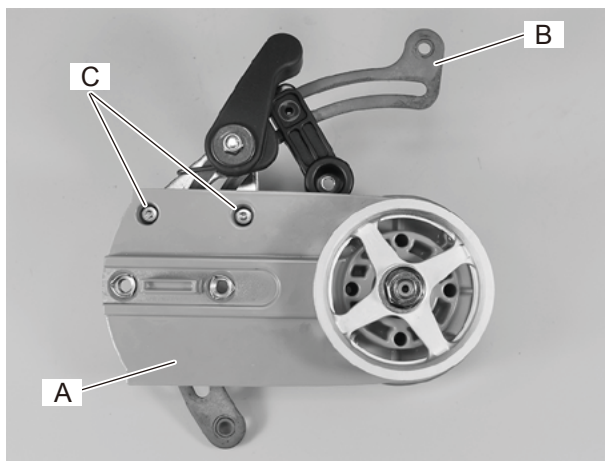

Removing pulley, drive shaft and ball bearing

1. Remove bearing case (A) and slide plate (B) from cutter cover assembly (Refer to "8-1 Disassembling cutter cover assembly").
2. Remove 2 pre-coated bolts (C).

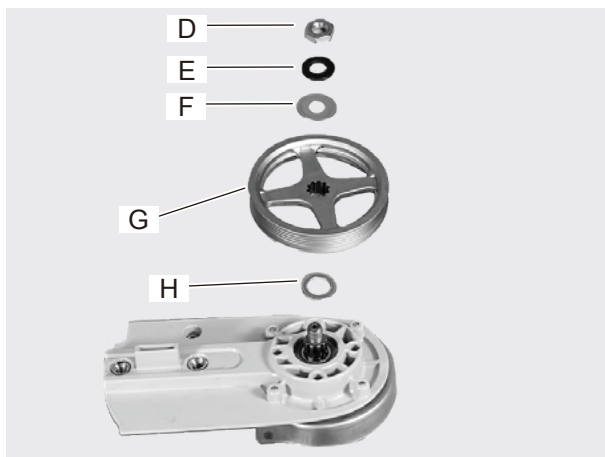

3. Insert bar tool into pulley (G) to prevent pulley rotating.
4. Remove nut (D), disk spring (E), washer (F), pulley (G) and washer (H).

8-2 Replacing pulley, drive shaft and ball bearing

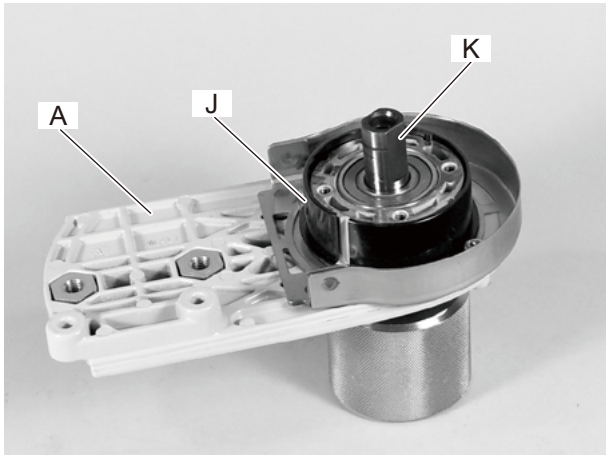

5. Remove sliding ring (J) from bearing case (A).
6. Heat bearing case (A) to remove ball bearing easier.

WARNING **DANGER**

When using a heat gun, wear gloves. Otherwise, a burn will result.

7. Push drive shaft (K) to remove drive shaft (K) with ball bearing from bearing case.

Installing drive shaft, ball bearing and pulley

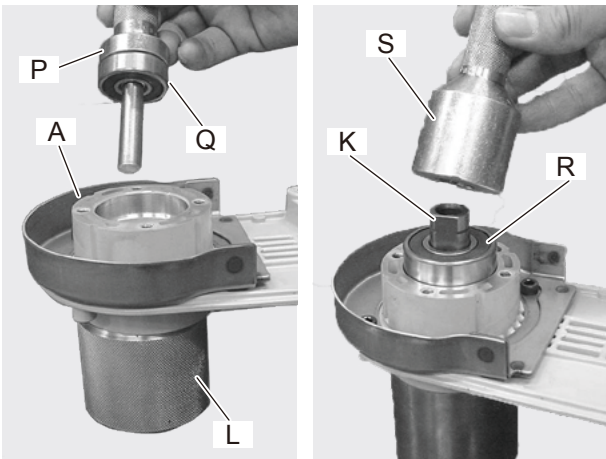

1. Heat bearing case (A) to install ball bearing easier.
2. Set bearing case (A) on Holder (L) 22169-96410 as shown.
3. Set ball bearing 6202LLU/DDU (Q) with Rod bearing X646-000050 (P) on bearing case (A).
4. Tap Rod bearing (P) using mallet or press the rod (P) to put ball bearing (Q) into bearing case (A).
5. Insert drive shaft (K) in ball bearing (Q).
6. Set ball bearing 6203 (R) on bearing case (A) as shown.
7. Tap Rod X646-000100 (S) using mallet or press the rod (S) to put ball bearing (R) into bearing case (A).

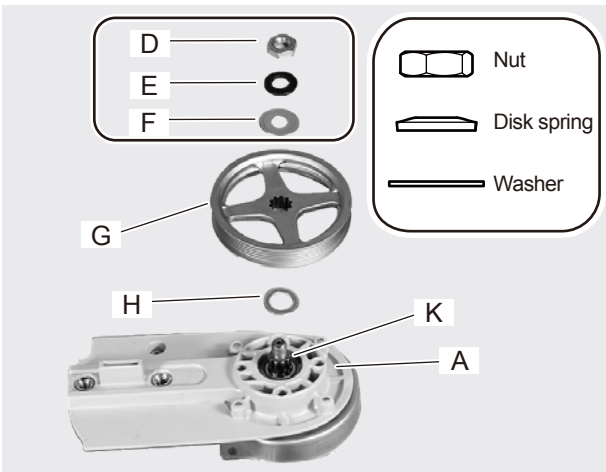

8. Set washer (H) on bearing case (A) and set pulley (G) on drive shaft (K).
9. Set washer (F) and disk spring (E) on pulley (G).
- 10 Tighten pulley with nut (D).

NOTE: Apply Thread locking sealant (ThreeBond #1377B or equivalent) to nut (D) to secure pulley.

8-3 Assembling cutter cover assembly

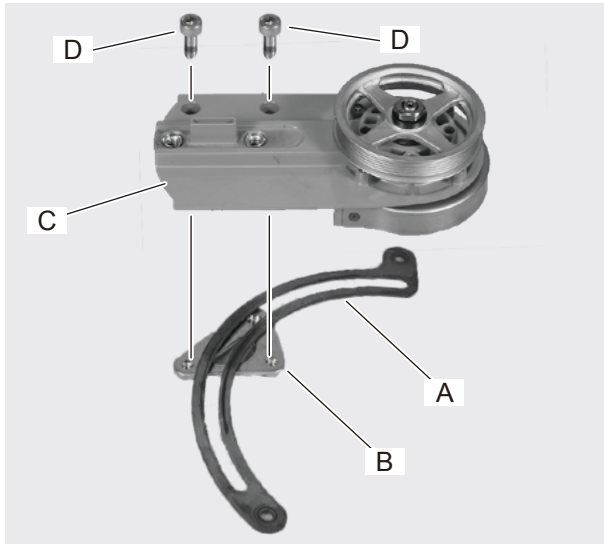

1. Set slide plate (A) on plate (B) as shown.
2. Tighten bearing case (C) and plate (B) with 2 pre-coated bolts (D).

NOTE: If the coat is peeled off, replace new one or apply ThreeBond #1344 or equivalent. If old thread locking sealant is left in threads, correct torque may not be secured. In case old thread locking sealant is left, remove it.

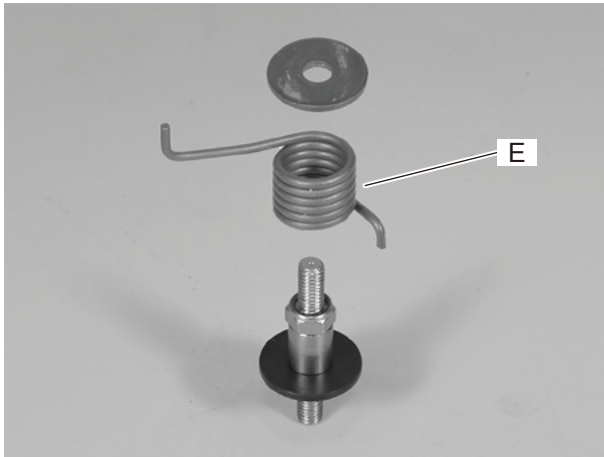

3. Assemble bolt, spring (E) and washers for cutter locking knob as shown.

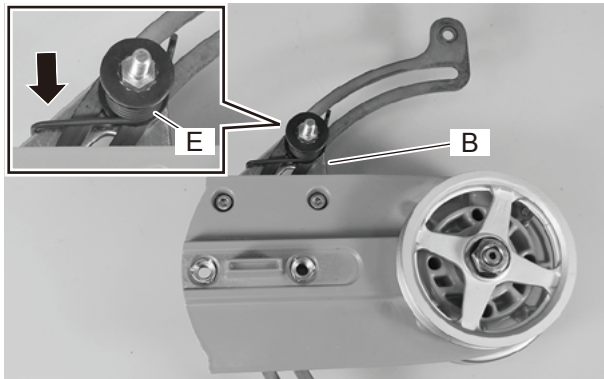

4. Install spring (E), bolt and washers assembled at step 3 to plate (B) as shown.

NOTE: Place the longer end of spring (E) on plate (B).

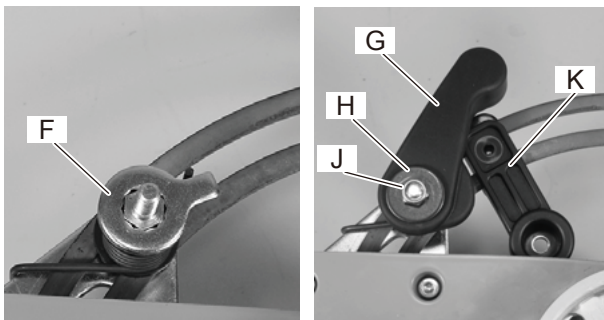

5. Set plate for knob (F) on spring (E) as shown.
6. Set lever (G) and washer (H) on plate for knob (F) and secure them with nut (J).
7. Install stopper (K) to slide plate as shown.

8-3 Assembling cutter cover assembly (Continued)

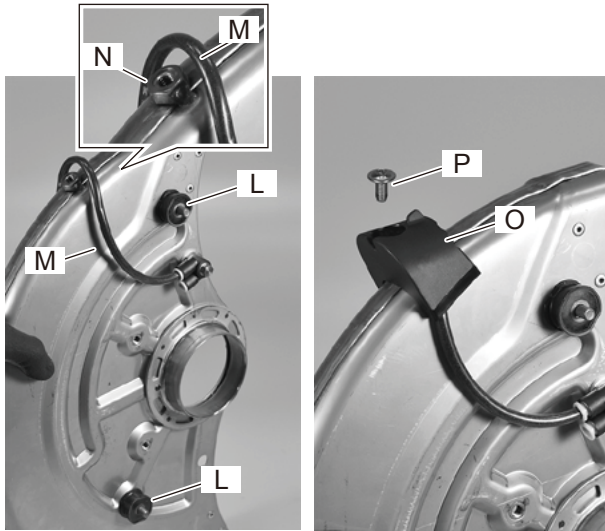

8. Install 2 cushions (L) on cutter cover.
9. Connect water flush pipe (M) to pipe connector.
10. Pass water flush pipe (M) over nut (N) on cutter cover as shown.
11. Place cutter cover knob (O) on the nut (N) and the pipe (M) and secure the knob (O) with bolt (P).

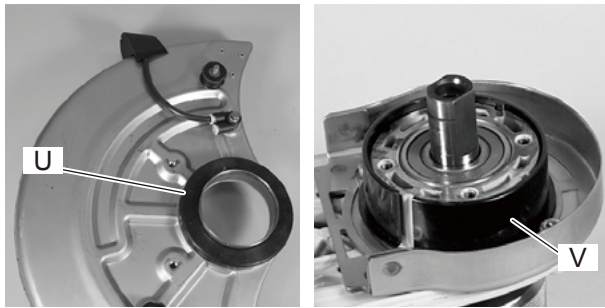

12. Place ring (U) on cutter cover as shown.
13. Place sliding ring (V) on bearing case as shown.

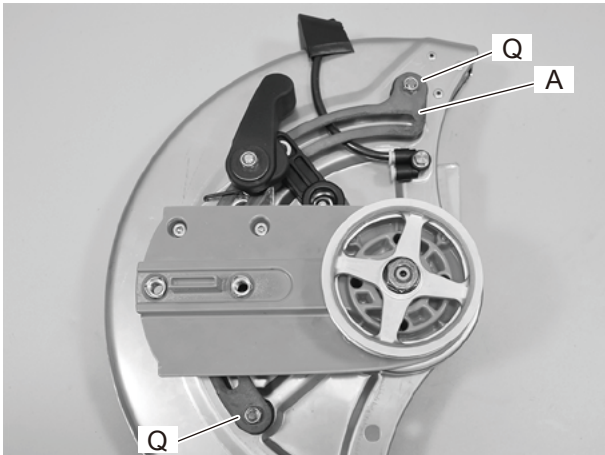

13. Install slide plate (A) on 2 cushions and secure with 2 nuts (Q).

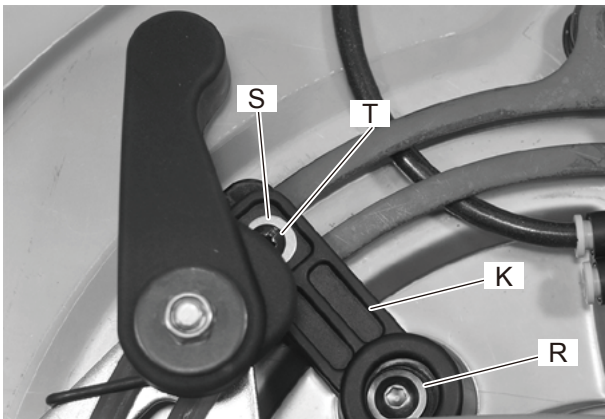

14. Secure stopper (K) with bolt (R).
15. Set washer (S) on stopper (K) and secure with screw (T) as shown.





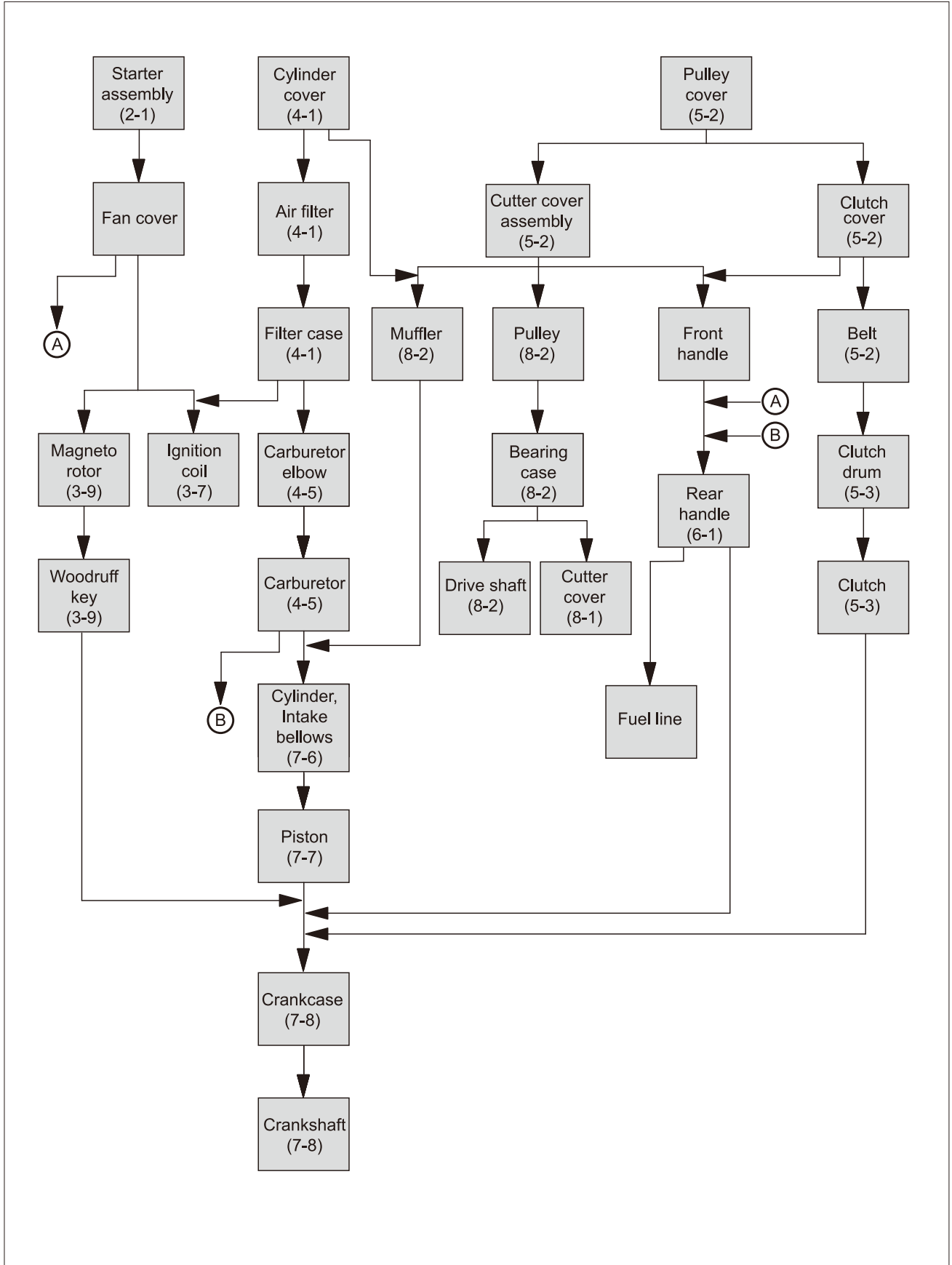









































9 MAINTENANCE GUIDE

9-1 Disassembly chart

























































































































9-2 Troubleshooting guide

TROUBLE	
Engine does not crank.	01
Engine does not start.	02
Poor / No spark	03
Spark plug is not wet.	04
Idling is not stable.	05
Acceleration is poor.	06
Engine lacks power.	07
Engine stops while running.	08
Engine seizure / overheat	09
Engine does not stop.	10
Fuel leaks	11
Engine / others are extremely noisy.	12
Vibration is excessive.	13
Cutter blade does not cut well	14

INSPECTING	REFERENCES	Inspecting  first.													
Starter system		14	13	12	11	10	09	08	07	06	05	04	03	02	01
Starter pawl/spring	2-4														
Starter rope / rope reel	2-2														
Power spring	2-2														
Rewind spring	2-2														
Ignition system		14	13	12	11	10	09	08	07	06	05	04	03	02	01
Sparks	3-2														
Spark plug	3-3														
Spark plug cap / coil	3-4														
Ignition switch	3-5														
Ignition coil	3-6, 3-7														
Pole shoe air gaps	3-8														
Leads	3-6														
Magneto rotor (Flywheel)	3-9														
Magneto rotor key (Woodruff key)	3-9														
(Continued)															

9-2 Troubleshooting guide (Continued)

INSPECTING	REFERENCES	Inspecting  first.													
		14	13	12	11	10	09	08	07	06	05	04	03	02	01
Fuel system / Carburetor															
Air filter	4-1														
Fuel cap / strainer	4-2														
Carburetor adjustment	4-14														
Fuel tank / line / vent	4-3, 4-5, 4-6														
Grommets	4-5, 4-13														
Carburetor leakage	4-4														
Carburetor metering lever height	1-2, 4-10														
Carburetor diaphragms	4-11														
Carburetor inlet needle valve	4-9														
Welch plug	4-12														
Crankcase pulse passage	4-8														
Fuel (octane / freshness / purity)															
2-stroke oil (grade / mix ratio)															
Clutch system / Belt driving system		14	13	12	11	10	09	08	07	06	05	04	03	02	01
Clutch drum	5-3														
Clutch	5-3														
Belt tension	5-1														
Belt	5-2														
Engine		14	13	12	11	10	09	08	07	06	05	04	03	02	01
Cooling air passage	7-1														
Muffler / Exhaust port	7-2														
Cylinder compression	1-2, 7-3														
Crankcase / Cylinder seal	7-4														
Crankcase / Cylinder	7-6														
Piston / Piston ring	7-7														
Crankshaft / Ball bearings	7-8														
Decompressor	7-5														
Intake bellows	7-6														
Cutting system		14	13	12	11	10	09	08	07	06	05	04	03	02	01
Pulley / Bearing / Drive shaft	8-2														
Cutter blade															
Others		14	13	12	11	10	09	08	07	06	05	04	03	02	01
Cushion	6-1														
Throttle trigger / Throttle rod	6-2, 4-13														

9-3 Service Intervals

Inspection point	Reference	Intervals		
		Before use	50 hours or 1year	100 hours
Cutter blade		✓		
Belt	5-1, 5-2	✓		✓
Cutter cover	8-1, 8-2	✓		
Flange	8-1	✓		✓
Air filter	4-1	✓	✓	
Fuel		✓		
Fuel leaks**	4-3, 4-5, 4-13	✓		
Fuel strainer	4-2		✓	
Fuel line / Grommet	4-3, 4-5, 4-13			✓
Fuel tank cap / O-ring	4-2			✓
Fuel tank	4-3	✓		
Spark plug	3-2, 3-3	✓		✓
Carbretor	4-4, 4-5, 4-9 to 4-13			✓
Cooling system	7-1	✓		
Muffler and Exhaust port	7-2	✓		
Clutch and Clutch drum	5-3			✓
Screws, Bolts and Nuts		✓		✓
Cushions	6-1	✓		✓

✓ ; Inspect / Clean / Repair

✓ ; Replace as required

IMPORTANT: Service intervals shown above are maximum. Actual use and your experience will determine the frequency of required maintenance.

* Retighten the following screws and bolts after first 1 week use, and every 3 months.

Cylinder cover screws (4 pcs.)

Starter assembly screws (4 pcs.)

Cushion bolts (6 pcs.)

Muffler bolts (4 pcs.)

** Inspect after every refuel.

ECHO[®]

shindaiwa[®]

YAMABIKO

Published by
YAMABIKO Corp.
Tokyo Japan
2005